



www.vdo.net.au



Catalogue 2016

VDO



We're focused on providing our customers with the best possible instrumentation – a goal that we've pursued since 1920. We continue to work to deliver the functionality, durability, and high quality finish that have earned our products a best-in-class reputation, worldwide. At the same time, we strive to continually pursue innovations that make our instrumentation more efficient, affordable, and useful to the people who own and operate vehicles and equipment that feature our products.

While we're aware of the vital role of our instruments as a human-machine interface and the importance of factors such as ergonomics, cost, and reliability, we haven't neglected aesthetics. In this catalogue you'll find Vision and Cockpit International lines, updated CANcockpit GEN III, the new fuel senders and complete accessories.

From rugged analog gauges to sophisticated, flexible CAN bus platforms, we're working to give our customers choice, flexibility, and style for all their monitoring needs.

www.vdo.net.au



CONTENTS



Cockpit Vision	4 - 13	Pressure Switches	56 - 57
Cockpit International	14 - 21	Temperature Switches	58
Hourmeters	21 - 22	Temperature Switches / Senders	59 - 60
PRT & Speedboat Kit	23	Adaptors	61
Cockpit Titanium	24 - 28	Fuel Senders & RPM Senders	62 - 63
Cockpit White	29 - 32	Speed Senders	64
Cockpit Digital	33 - 36	Vehicle Application Listing	65 - 81
Marine	37 - 39	Electronic Switch Boxes	82 - 83
Trailer Weighing Systems	40	Gauge Check / Tyre / Speed Alert	84
Central Locking	41	Gauge Housing	85
Speakers & Radios	42 - 43	Gauge Accessories	86
Alarms & Starter Switches	44	Globes	87
Reversing Cameras	45	Conversion Tables	88
Cruise Control	46 - 53	Part Number Index	89 - 92
Pressure Senders	54 - 55		

Cockpit Vision

Speedometers, automotive	4
Boat Speedo, marine	4
Tachometers	5
Tachourmeter	5
Fuel Gauges	6
Pressure Gauges, electrical	7 - 8
Pressure Gauges, mechanical	8
Boost Gauges, mechanical	9
Turbo Charger Gauge, mechanical	9
Vacuum Gauge, mechanical	9
Temperature Gauges, mechanical	10
Temperature Gauges, electrical	10 - 11
Exhaust Temperature / Pyrometer, electrical	12
Voltmeter	12
Ammeters, with internal shunt	12
Ammeters, with external shunt	13
Clock, analogue / digital	13

Cockpit International

Speedometers, electrical	14
Tachourmeters, electrical with LCD Hourmeter	15
Tachometers, electrical	15
Fuel Gauges, electrical	16
Pressure Gauges, mechanical	17
Pressure Gauges, mechanical dual pointer	17
Pressure Gauges, electrical	18
Temperature Gauges, electrical	19
Temperature Gauges, mechanical	20
Pyrometer, electrical	20
Ammeters, with internal shunt	21
Voltmeters	21
Hourmeter, electrical - rectangular type, LCD	21
Hourmeters, electrical	22
PRT Tachometers	23
Speedboat Kit	23

Cockpit Titanium

Speedometer, automotive	24
Boat Speedo, marine	24
Tachometer	25
Fuel Gauge, electrical	25
Voltmeter	26
Turbo Charger Gauge, mechanical	26
Oil Pressure Gauges, electrical	27
Temperature Gauges, electrical	27 - 28

Cockpit White

Tachometers	29
Speedometers, automotive	29
Boat Speedo, marine	29
Fuel Gauge, electrical	30
Pressure Gauge, electrical	30
Pressure Gauge, mechanical	31
Turbo Charger Gauge, mechanical	31
Voltmeter	31
Exhaust Temperature / Pyrometer, electrical	32
Temperature Gauge, electrical	32

Cockpit Digital

Turbo Gauge, digital	33
Air Fuel Ratio Gauge, digital	33
Pressure Gauge, digital	33
Temperature Gauges - Water, digital	34
Temperature Gauges - Oil, digital	34
Voltmeter, digital	35
Pyrometer, digital	35
Fuel Gauge / dual, digital	36
Tachometer, digital	36

Marine

Tachourmeter	37
Temperature Gauges	37
Pyrometer Gauges	37
Pressure Gauges	38
GPS Speed Gauges	38
Fuel Gauges	39
Voltmeters	39
Multifunction Gauges	39

Kimax

Kimax I, Cabin	40
Kimax I, Trailer	40
Kimax II, Cabin	40

Central Locking

Keyless Entry - Remote Controlled	41
Keyless Entry with Alarm / Immobiliser	41
Remote Controlled Central Locking kit	41
Central Locking Kit	41

Speakers & Radios

Speakers	42
Radios	43

Alarms & Starter Switches

Low Water Alarm	44
Warning Lights	44
Warning Buzzers	44
Starter Switches	44

Reversing Cameras

Reversing Screens	45
Reversing Cameras	45
Camera Extensions Cables	45
DVR	45

Cruise Controls

Universal Cruise Controls	46
Cruise Controls	47 - 53

Senders, Switches & Adaptors

Pressure Senders & Switches	54-55
Oil Pressure Senders Specification	55
Pressure Switches - Oil Light	56
Pressure Switches Heavy Duty	57
Temperature Switches	58
Temperature Senders & Switches	59
Temperature Senders Specification overview	60
Adaptors, brass	61
T-Piece Adaptors	61
Fuel Level Senders	62
Tank Unit Sender Accessories	62
Reed Switch Senders	62
Tubular Type Senders	63
RPM Senders	63
Hall Effect Senders	64
Speedometer Senders	64
Drive Keys	64
Vehicle Application Listing - Oil /Temp	65 - 81

Electronic Switch Boxes

Electric Adjustable Switch Box	82
Multi-Frequency Switch Box 1 Ch Rev Switch	82
Electronic Ratio Box	83
Signal Amplifier/Divider	83
Gauge Ohms Conversion Box	83

Accessories

Digital Hand Held Tachometers	84
Tyre Pressure Gauge	84
Gauge Check	84
Oil Pump, electrical	84
Housing Binnacles, plastic	85
Housing, plastic	85
Housing, metal, and related components	85
Instrument Panels, metal black	85
Clamp Rings & Stud Kits	86
Anti-Glare Spacer	86
Instrument Blank, plastic black	86
Reduction Rings, metal black	86
LED Globes	87
Globe Holders & Globes	87
Globes	87
Light Covers	87
Wiring Kits	87

Conversion Tables

Conversion Tables	88
-------------------	----

Part Number Index

Part Number Index	89 - 92
-------------------	---------

COCKPIT VISION

THRU DIAL ILLUMINATION

Cockpit Vision is the pinnacle of instrument technology. It represents latest advances in instrument illumination and installation techniques.

Using fibre-optic technology to illuminate the pointer and VDO's Trioptic through dial lighting we achieve superb night time illumination.

SPEEDOMETERS, automotive

Illumination through dial and pointer. 12V globe included.

Field adjustable to suit 500 to 400,000 imp/km by pulse setting, or auto-calibration function through LCD readout via reset button.

Signal source Hall-effect, inductive or blocking oscillator sender units.



170.702

Speedometer - Electronic

Part No.	Range	Size	Voltage
437015028	0 - 200km/h	80mm	12/24V
437015021	0 - 300km/h	80mm	12/24V
437015025	0 - 200km/h	85mm	12/24V
437015022	0 - 300km/h	100mm	12/24V
437015029	0 - 200km/h	100mm	12/24V
437015007	0 - 150km/h	100mm	12/24V

Note: 8 pin plug kit part no. 340.824 recommended. Not included in kit.

Speedometer

Part No.	Range	Size	Voltage
437015038	0 - 125km/h	140mm	12V
437025002	0 - 125km/h	140mm	24V

Note: 140mm Speedometer Impulse Ratio programmable 1,000-60,000 pulses/Km. 8 pin plug kit part no. 340.824 recommended. Not included in kit.

HALL EFFECT SENDERS

Proximity Switch & Hall Effect

Part No.	Voltage	Thread	Type	Imp/Rev	Plug Kit
K46004	12V	7/8"-18UNF	H/E	8	K72221
K46020	12/24V	M22x1.5	H/E	8	K72221
L/H male					
K46021	12/24V	7/8"-18UNF	H/E	8	K72221

Note: Part numbers supplied without Plug Kit

BOAT SPEEDO, marine

The Pitot Tube Speedo is designed to determine the speed of a boat over water. It consists of a Pitot tube foot and hose to transfer air pressure to the speedo head system where the air pressure is converted to speed.

Speedometer - Gauge

Part No.	Range	Size	Voltage
260.111	50mph	85mm	12V

Pitot Kit

Part No.	Description
170.702	pitot tube assembly black

TACHOMETERS

Suitable for most petrol and diesel engines. Field programmable to suit 4, 6 or 8 cyl./4 stroke ignition and alternator pick-up (terminal "W"). Single phase, not suitable for star point or magneto system. For standard, points ignition system, add a 1N4004 diode in series with the signal wire (cathode towards tach). Illumination 12V included.

Tachometer - Electronic

Part No.	Range	Size	Voltage
333015037	0 - 4000rpm	52mm	12V
333015031	0 - 8000rpm	52mm	12V
333015038	0 - 4000rpm	80mm	12V
333015032	0 - 7000rpm	80mm	12V
333015046	0 - 10000rpm	80mm	12V
333015033	0 - 7000rpm	85mm	12V
333015034	0 - 8000rpm	100mm	12V

Note: 8 pin plug kit part no. 340.824 recommended. Not included in kit.

For external shift-light, use rev-switch p/n 660.990

Illumination Globe & Socket: 12V = p/n 800005002, 24V = p/n 800005003

Light Globe (only): 12V = p/n 240.052, 24V = p/n 240.053



TACHOURMETER

Suitable for most petrol and diesel engines. Adjustable through LCD and reset button. Field programmable to 1, 2, 3, 4, 5, 6, 8 or 12 cyl./4-stroke, 1, 2, 3 or 4 cyl./2-stroke ignition and alternator pick-up ("W" terminal). Also suitable for signal from generator or inductive sender unit but not suitable for magneto ignition system. Incorporated hourmeter shows true engine hours. Operating hours 99,999.9. Pulse range 0.5-200 pulses per rev. Illumination 12V included.

For 24V application use globe #240.053 (2 required).

For matching sender units refer to page 64.

Tachourmeter - Electronic

Part No.	Range	Size	Voltage
333015035	0 - 7000rpm	85mm	12/24V
333015047	0 - 3000rpm	100mm	12/24V

Note: 8 pin plug kit part no. 340.824 recommended. Not included in kit.



FUEL GAUGES

Suitable for use with most petrol, diesel fuel, and LPG systems.
Illumination 12V included.



Adjustable Float Arm Sender 220.003

Fuel Gauge - Float Arm Sender			52mm
Part No.	Description	Specifications	Voltage
301010011	Fuel gauge (float arm)	3 - 180 ohms	12V
301.105	Fuel gauge for USA application	240 - 33 ohms	12V
301010010	Fuel gauge Suits 5 - 90 ohms LPG tank unit senders and petrol & diesel.	5 - 90 ohms	12V

Note: 3 pin plug kit part no. 240.030 recommended. Not included in kit.
Float ball for p/n 220.003 is p/n 88161006

Sender - Adjustable Float Arm		
Part No.	Specifications	Length
220.003	3 - 180 ohms	150 - 600mm
220.004	5 - 90 ohms	150 - 600mm
220.005	240 - 33 ohms	150 - 600mm

Note: Mounting kit part no. N05801432 not included in kit.

Fuel Gauge - Lever			
Part No.	Description	Ohms	Voltage
301.001	Fuel gauge-lever	3 -180 ohms	24V

Note: 3 pin plug kit part no. 240.030 recommended. Not included in kit.



Sender-Tubular Tank



Flange Mounting Kit N05801432

Fuel Gauge - Tubular				
Part No.	Description	Ohms		Voltage
		Empty	Full	
301010009	Fuel gauge-tubular	110/50	2 ohms	12V
301.002	Fuel gauge-tubular			24V

Note: 3 pin plug kit part no. 240.030 recommended. Not included in kit.

Tubular Type Sender

See complete listing of tubular type senders on page 63.

Note: Mounting kit part no. N05801432 not included in kit.

Accessories		
Part No.	Description	PCD
N05801432	Flange mounting kit	54mm

Note: For more Accessories, refer to page 62.



Fuel Gauge - OE Senders			
Part No.	Description	Specifications	Voltage
301010015	Suits OE senders	73 -10 ohms	12V
Holden	HJ - HX - HZ - LH - LX		
Ford	XR - XT - XW - XY - XA - XB - XC - 2F - 2G - 2H		

500 Kpa PRESSURE GAUGE, electrical

Suitable for most vehicles.

Illumination 12V included.

Adaptors are listed on page 61.

Electric Pressure Gauge - 500Kpa			52mm
Part No.	Description	Specifications	Voltage
350010016	Oil pressure symbol on dial	500Kpa 10-184 ohms	12V
350040011	Oil pressure symbol on dial	1000Kpa 10-184 ohms	24V

Note: 3 pin plug kit part no. 240.030 recommended. Not included in kit.

Sender			10-180 ohms
Part No.	Range	Thread	Terminal
360.001	500Kpa	1/8"-27NPTF	Spade
360.004	500Kpa	1/4"-18NPTF	Button
360.016	500Kpa	1/8"-28BSBT	Button
360.018	500Kpa	1/8"-27NPTF	M4 thread
360081030049K	5 Bar / 7 psi SW N/C	1/8"-27NPTF	M4 thread

Refer to your engine manufacturers manual for correct oil pressure ratings.

Note: 500 Kpa = 5 Bar = 72.5 psi



Sender 360.001

1000 Kpa PRESSURE GAUGE, electrical

Suitable for most vehicles.

Illumination 12V included.

Adaptors are listed on page 61.

Electric Pressure Gauge - 1,000Kpa			52mm
Part No.	Description	Specifications	Voltage
350010017	Oil symbol on dial	1000Kpa 10-180 OHMS	12V
350020001	10 Bar	10-180 OHMS	24V

Note: 3 pin plug kit part no. 240.030 recommended. Not included in kit.

Senders			10-180 ohms
Part No.	Range	Thread	Terminal
360.002	1000Kpa	1/8"-27NPTF	Spade
360.019	1000Kpa	1/8"-27NPTF	M4 thread
360081030052C	10 Bar / 7 psi SW	1/8"-27NPTF	M4 thread

Refer to your engine manufacturers manual for correct oil pressure ratings.

Note: 1000 Kpa = 10 Bar = 145 psi



Sender 360.002



Sender 360.086



Oil line kit 230.012



Nut and cone 230.008



Engine fitting 230.024



Nut and cone 230.025

PSI PRESSURE GAUGE, electrical

Suitable for most vehicles.
Illumination 12V included.

Pressure Gauge - 100psi			52mm
Part No.	Description	Specification	Voltage
350010021	Oil Gauge	100psi	12V
360.086	Sender 100psi	1/8"-27NPTF	12/24V

Note: 3 pin plug kit part no. 240.030 recommended. Not included in kit.

Pressure Gauge - 400psi			52mm
Part No.	Range	Specification	Voltage
350010001	Trans Gauge	400psi	12V
360081038003C	Sender 400psi	1/8"-27NPTF	12/24V
360081038008C	Sender 400psi	1/8"-27NPTF	12/24V

Refer to your engine manufacturers manual for correct oil pressure ratings.

Note: 2800 Kpa = 28 Bar = 406 psi

* (0 - 25 Bar Sender is insulated return and can be used for 400 Psi gauge application)

PRESSURE GAUGES, mechanical

Suitable for most vehicles.
Supplied with nut and cone to suit 3/16" PVC tubing.
Illumination 12V included.

Note: 24V Globe - 240.053

Pressure Gauge - Air, Oil & Water		52mm
Part No.	Range	Size
150077027	0 - 100psi	52mm
150077026	0 - 150psi	52mm
150077020	0 - 700Kpa	52mm

Accessories

Part No.	Description
230.012	1.8m fitting kit - 3/16" PVC tubing & engine fitting
230.013	5m fitting kit - 3/16" PVC tubing & engine fitting

Fitting Kit

Part No.	Description
230.008	Nut and cone for 3/16" PVC Tubing, M12x1.5 thread
230.024	Engine fitting 1/8"-27NPTF male, 3/16" tubing
230.025	Nut and cone 1/8"-27NPTF nut
230.015	Air/Fuel pressure restrictor

BOOST GAUGES, mechanical

Suitable for diesel vehicles.

Supplied with nut and cone to suit 3/16" PVC tubing.

Illumination 12V included.

Boost Gauge		52mm
Part No.	Range	Size
150077010	0-15 psi	52mm
150077011	0-30 psi	52mm

Note: Use airline kit 230.012 or 230.013
Accessories on page 10.
Includes Air Restrictor: 10027



TURBO CHARGER GAUGE, mechanical

Suitable for petrol vehicles.

Supplied with nut and cone to suit 3/16" PVC tubing.

Illumination 12V included.

Turbo Charger Gauge		52mm
Part No.	Range	Size
150077004	-30" Hg/+25psi	52mm

Hg = Negative 30 inches of vacuum of mercury.

Note: Use airline kit 230.012 or 230.013
Accessories on page 10.
Includes Air Restrictor: 10027



VACUUM GAUGE, mechanical

Suitable for most vehicles.

Supplied with nut and cone to suit 3/16" PVC tubing.

Illumination 12V included.

Vacuum Gauge		52mm
Part No.	Range	Size
150077005	-30-0" Hg	52mm

Hg = Negative 30 inches of vacuum of mercury.

Note: Use airline kit 230.012 or 230.013
Accessories on page 8.
Includes Air Restrictor: 10027

Accessories	
Part No.	Description
230.013	5m fitting kit - 3/16" PVC tubing & engine fitting



TEMPERATURE GAUGES, mechanical

Suitable for most vehicles.

Process connection is 1/8"-27NPTF threaded removable thermowell.

Temperature is transmitted via capillary tube.

Coil up excess capillary tubing - do not cut to shorten!

Illumination 12V included. For 24V application use globe part no. 240.503.

Adaptors are listed on page 61.



Thermowell 180.059



Temperature Gauge - Water		52mm
Part No.	Range	Capillary Length
180077022	40 - 120°C	1600mm
180077023	40 - 120°C	2600mm
180077021	40 - 120°C	4000mm

Temperature Gauge - Oil		52mm
Part No.	Range	Capillary Length
180077020	50 - 150°C	1600mm
180077019	50 - 150°C	4000mm

Note: Thermo well included.

Accessories		
Part No.	Description	Note
180.059	Thermowell 1/8"-27NPTF	Suits adaptors # 320.xxx

Note: Refer page 61 for adaptors.

Note: 180.059 supplied in all new temperature gauge kits.

Adaptors Brass			
Part No.	Internal Thread	External Thread	Overall Length
320.050	1/8"-27NPTF	1/4"-18NPTF	20mm
320.051	1/8"-27NPTF	3/8"-18NPTF	20mm
320.052	1/8"-27NPTF	5/8"-18UNF	20mm
320.053	1/8"-27NPTF	1/2"-14NPTF	20mm
320.054	1/8"-27NPTF	M14x1.5	20mm
320.055	1/8"-27NPTF	M16x1.5	20mm
320.056	1/8"-27NPTF	M18x1.5	20mm

TEMP GAUGE, electrical

Outside Temperature Gauge			
Part No.	Description	Range	Voltage
310.005	Outside Temp Gauge - Analogue	-20°C - 60°C	12V

Note: Sender provided - 5mm eyelet.

120° TEMP GAUGE, electrical

Suitable for most vehicles.

Illumination 12V included.

For more matching sender units refer to page 60.

Adaptors are listed on page 61.

Temperature Gauge - Water				52mm
Part No.	Description	Specifications	Voltage	
310010014	Water temp. symbol on dial	40 - 120°C 287-23 ohms	12V	
310020001	Water temp.	40 - 120°C	24V	

Note: 3 pin plug kit part no. 240.030 recommended. Not included in kit.

Temperature Sender				
Part No.	Range	Thread	Terminal	Body Type
320.002	40 - 120°C	1/8"-27NPTF	button	a
320.093	40 - 120°C	1/8"-27NPTF	M4 thread	b
320.022	40 - 120°C	1/2"-14NPTF	spade	c
320.004	40 - 120°C	M16x1.5mm	button	a

Note: 40 - 120°C = 100 - 250°F

For calibration specs, see page 88.

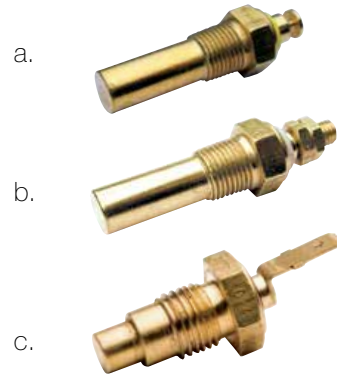

150° TEMP GAUGE, electrical

Temperature Gauge - Oil				52mm
Part No.	Description	Specifications	Voltage	
310010015	Engine oil temp. symbol on dial	50 - 150°C 323-18 ohms	12V	
310020002	Oil temp.	50 - 150°C	24V	

Note: 3 pin plug kit part no. 240.030 recommended. Not included in kit.

Temperature Sender				
Part No.	Range	Thread	Terminal	Body Type
320.021	50 - 150°C	1/8"-27NPTF	button	a
320.028	50 - 150°C	1/8"-27NPTF	button	d
320.092	50 - 150°C	1/8"-27NPTF	M4 thread	b
320.010	50 - 150°C	M12x1.5mm	button	a
320.072	50 - 150°C	1/8"-27NPTF	M4 thread	f

Note: 50 - 150°C = 120 - 300°F

p/n 320.070 NLA use p/n 320.092

For calibration specs, see page 88.

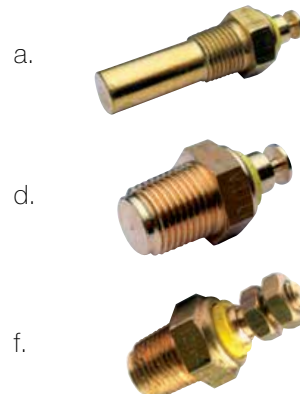



Thermocouple 320.714

EXHAUST TEMPERATURE / PYROMETER, electrical

Suitable for most exhaust systems.

Thermocouple connection is by 1/4"-18NPTF compression fitting.

Temperature is transmitted via K-type compensating cable.

Illumination 12V included. For 24V application use dropping resistor part no.

N05801180 and globe part no. 240.053.

Pyrometer - Electrical Kit		52mm
Part No.	Range	Voltage
310.159	0 - 900°C (37.6mV@900°C)	12V

Note: Cutting or adding length of loom will not affect calibration.

Spare Parts for 310.159 exhaust temperature/pyrometer kit	
Part No.	Description
310015009	Instrument
320.714	Thermocouple 1/4"-18 NPTF non bonded junction "K" type to be fitted 100mm after the turbo
240.035	Loom, 5m
320.059	Weld boss 1/4"-18 NPTF
240.733	Globe & Socket 12V (800005003 Globe & Socket 24V not incl.)

Note: p/n 320.714 probe length = 62 mm, adjustable. Loom length ~ 500 mm



VOLTMETER

Suitable for most engines/vehicles where battery and charging systems need to be monitored.

Illumination 12V included.

Voltmeter		52mm
Part No.	Range	Voltage
332010004	8 - 16V	12V
332020001	18 - 32V	24V

Note: 2 pin plug kit part no. 240.031 recommended. Not included in kit.

AMMETERS, with internal shunt

Suitable for most engines which require battery and charging system monitoring.

Voltage dependent - suitable for 12V or 24V.

Ammeters with internal shunt are easily identified by the heavy duty threaded terminals on the back of the instrument.

Illumination 12V included.

Ammeter with Internal Shunt - metal body			52mm
Part No.	Description	Specifications	Voltage
190077006	30-0-30 amp gauge	use 6mm wire	12V
190077007	60-0-60 amp gauge	use 6mm wire	12V

AMMETERS, with external shunt

Suitable for monitoring heavy duty electrical charging system.
Voltage dependent - suitable for 12V or 24V.
Illumination 12V included. For 24V application use dropping resistor
N05801180 and globe 240.051.

Ammeter with External Shunt			52mm
Part No.	Description	Specifications	Voltage
190.504	150-0-150 ammeter kit		12V

Note: For installation use 10mm wire.

Spare Parts for 190.504 ammeter kit		
Part No.	Description	Specifications
190075004	150-0-150 gauge, 52mm	
190.080	Shunt - 150 amps	50mV @ 150 amps
190.888	5m loom	



CLOCK, analogue

Suitable for most vehicles.
Features a 12V quartz movement for high accuracy.
Illumination 12V included.

Clock		52mm
Part No.	Description	Voltage
370.001	LED Illumination	12/24V

Note: 2 pin plug kit part no. 240.031 recommended. Not included in kit.



CLOCK LCD, digital

Clock		52mm
Part No.	Description	Voltage
370.701	12 Hr	12V



CLOCK LCD, digital

Clock		12V
Part No.	Description	Size
370.311	12 Hr - Digital Display On / Off Alarm function	102x40mm



COCKPIT INTERNATIONAL

OLD STYLE LIGHTING AROUND THE EDGE OF THE DIAL

Cockpit International represents a range of heavy duty instruments designed for the commercial and industrial market. The best combination of colours for readability and reduced eye fatigue are used in the styling of our cockpit instruments.

State of the art manufacturing and quality control procedures ensure that the end product features up to date engineering and design standards, such as the unique air core electric movements. These reliable gauges feature easy to read floodlit dial illumination for accurate referencing.



SPEEDOMETERS, electrical

The features of the programmable speedometer are a w/resettable LCD trip odometer with a push button and the trip odometer is displayed in the LCD window. Unique auto-calibration feature allows for easy adjustment and can be used with Hall Effect and inductive senders or most electronic controlled transmissions outputs.

Floodlit illumination. 12V globe included.

Field adjustable to suit 500 to 400,000 imp/km by pulse setting, or auto-calibration function through LCD readout via reset button. Total distance 999,999.9 not resettable. Speed display analogue; Odometer and trip distance LC-display trip distance 99,999.9 resettable.

Signal source Hall-effect, inductive or blocking oscillator sender units.

For 24V application use globe #240.053 (2 required).

For speed sensor units refer to page 64.

Speedometer

Part No.	Range	Size	Voltage
437035016	0 - 120km/h	85mm	12/24V
437055001	0 - 60km/h	100mm	12/24V
437055011	0 - 120km/h	100mm	12/24V

Note: 8 pin plug kit part no. 340.824 recommended. Not included in kit.

Hall Effect Sender

Part No.	Voltage	Thread	Type	Imp/Rev	Plug Kit
K46020	12/24V	M22x1.5 L/H male	H/E	8	K72221
K46021	12/24V	7/8" - 18UNF	H/E	8	K72221
340.808		M22 x 1.5mm Inc. 5mm dia lug drive key		8	In line

In line suits various vehicles with M22 nut size



Hall Effect Sender

TACHOURMETERS, electrical with LCD Hourmeter

The programmable tachometer w/LCD hourmeter can be used with most engine electronic control ignitions with tachometer output terminal, standard coil ignition, alternator signal, and 12V square wave applications. Non-resettable engine hourmeter is displayed in LCD windows.

Suitable for most petrol and diesel engines. Adjustable through LCD and reset button. Field programmable to 1, 2, 3, 4, 5, 6, 8 or 12 cyl./4-stroke, 1, 2, 3 or 4 cyl./2-stroke ignition and alternator pick-up ("W" terminal). Also suitable for signal from generator or inductive sender unit. Incorporated hourmeter shows true engine hours. Operating hours 99,999.9. Pulse range 0.5-200 pulses per rev. Not suitable for magneto system.

Illumination 12V included. For 24V application use globe #240.053 (2 required). For matching sender units refer to page 65.

Tachourmeter - for inductive sender			
Part No.	Range	Size	Voltage
333035010	3000rpm	80mm	12/24V
333035011	4000rpm	80mm	12/24V
333035025	3000rpm	85mm	12/24V
333035013	4000rpm	85mm	12/24V
333055002	3000rpm	100mm	12/24V

Note: 8 pin plug kit part no. 340.824 recommended. Not included in kit.



TACHOMETERS, electrical

Suitable for most petrol and diesel engines. Field programmable to 4, 6 or 8 cyl./4-stroke ignition and alternator pick-up ("W" terminal).

Single phase not suitable for star point or magneto system.

Illumination included.

Tachometer			
Part No.	Range	Size	Voltage
333035002	4000rpm	80mm	12V
333045002	4000rpm	80mm	24V
333035004	3000rpm	85mm	12V
333065001	3000rpm	100mm	24V

Note: 8 pin plug kit part no. 340.824 recommended. Not included in kit.



FUEL GAUGES, electrical

Suitable for use with most petrol, diesel fuel, and LPG systems.
Illumination 12V and 24V included.

For matching sender units refer to page 62.



Fuel Gauge - 3-180 ohms		52mm	
Part No.	Range	Size	Voltage
301 030 001	0-1/1	52mm	12V
301 040 001	0-1/1	52mm	24V

Note: 3 pin plug kit part no. 240.030 recommended. Not included in kit.
Without ISO symbol.

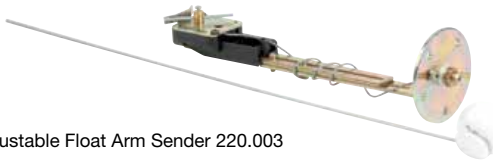

Adjustable Float Arm Sender 220.003

Sender - Adjustable Float Arm		
Part No.	Specifications	Length
220.003	3 - 180 ohms	150 - 600mm

Note: Mounting kit part no. N05801432 not included in kit.

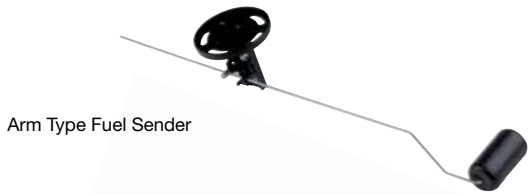

Arm Type Fuel Sender

Arm Type Fuel Sender

See complete listing of arm type fuel senders on page 62.

Note: Mounting kit part no. N05801432 not included in kit.
Suitable for 3 - 180 and 10 - 180 Ohms



Reed Switch Sender

Reed Switch Sender Fuel & Water

Just for 3 - 180 ohms gauges.

See complete listing of arm reed switch senders on page 62.

Note: Mounting kit part no. N05801432 not included in kit.
Suitable for 3 - 180 and 10 - 180 Ohms



Fuel Gauge - Tubular		52 mm	
Part No.	Range	Size	Voltage
301030002	0-1/1	52mm	12V
301040002	0-1/1	52mm	24V

Note: 3 pin plug kit part no. 240.030 recommended. Not included in kit.
With ISO symbol.
For tubular tank units, adjustable resistance.

Tubular Type Sender

See complete listing of tubular type senders on page 63.

Note: Mounting kit part no. N05801432 not included in kit.

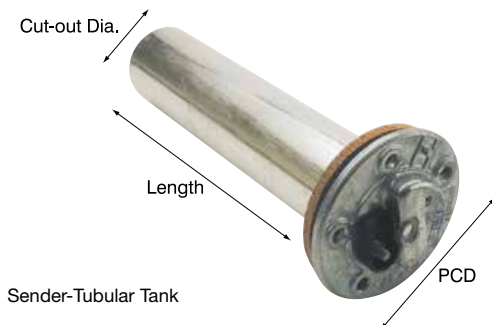

Sender-Tubular Tank

Accessories

Part No.	Description	PCD
N05801432	Flange mounting kit	54mm

Note: More Accessories, refer to page 62.

PRESSURE GAUGES, mechanical

Suitable for most vehicles and machines. Can be used on most non-aggressive gases and liquids. Supplied with nut and cone for 3/16" PVC tubing. Illumination 12V included.

For 24V application use globe part no. 240.053

Pressure Gauge		52mm
Part No.	Range	Voltage
150035020	0 - 1000Kpa	12V
150035022	0 - 2500Kpa	12V



PRESSURE GAUGES, mechanical dual pointer

Suitable for most vehicles and machines. Two independent measuring systems indicated separate pressures on one scale.

Supplied with nut and cone for 3/16" PVC tubing.

Illumination 12V and 24V globes included. Part no. 240.053

Dual Pressure Gauge		
Part No.	Range	Size
150.316	0 - 1000Kpa	60mm
151.910	0 - 150 psi	52mm
230.068	Nut and cone for 150.316	

Accessories	
Part No.	Description
230.012	1.8m fitting kit - 3/16" PVC tubing & engine fitting
230.013	5m fitting kit - 3/16" PVC tubing & engine fitting
230.008	Nut and cone for 3/16" PVC tubing, M12x1.5 thread
230.024	Engine fitting 1/8"-27NPTF male, 3/16" PVC tubing
230.025	Nut and cone 1/8"-27NPTF nut



Oil line kit 230.012



Nut and cone 230.008



Engine fitting 230.024



Nut and cone 230.025



Sender 360.001



Sender 360.002



Sender 360 081 038 003C



PRESSURE GAUGES, electrical

Suitable for most vehicles and machines. Illumination 12V or 24V included.

Note: Not recommended for petrol.

Adaptors are listed on page 61.

Pressure Gauge - Engine Oil Pressure		52mm
Part No.	Range	Voltage
350030016	0 - 500Kpa	12V
350040016	0 - 500Kpa	24V

Note: 3 pin plug kit part no. 240.030 recommended. Not included in kit.

With ISO symbol.

500Kpa = 5Bar = 72.5 psi

Sender - 500Kpa			10-180 ohms
Part No.	Range	Thread	Terminal
360.001	500Kpa	1/8"-27NPTF	Spade
360.004	500Kpa	1/4"-18NPTF	Button
360.016	500Kpa	1/8"-28BSBT	Button
360.018	500Kpa	1/8"-27NPTF	M4 thread

Note: 500 Kpa = 5 Bar = 72.5 psi

Refer to your engine manufacturers manual for correct oil pressure ratings.

For thread adaptors see page 61. For additional pressure senders see page 55.

For calibration specs, see page 88.

Pressure Gauge - Engine Oil Pressure		52mm
Part No.	Range	Voltage
350030017	0 - 1000Kpa	12V
350040017	0 - 1000Kpa	24V

Note: 3 pin plug kit part no. 240.030 recommended. Not included in kit.

With ISO symbol.

1000Kpa = 10 Bar = 145 psi

For thread adaptors see page 61. For additional pressure senders see page 55.

Senders			10-180 ohms
Part No.	Range	Thread	Terminal
360.002	1000Kpa	1/8"-27NPTF	Spade
360.019	1000Kpa	1/8"-27NPTF	M4 thread
360081030052C	10 Bar / 7 psi SW	1/8"-27NPTF	M4 thread

Refer to your engine manufacturers manual for correct oil pressure ratings.

Note: 1000 Kpa = 10 Bar = 145 psi

For calibration specs, see page 88.

Pressure Gauge - Transmission Oil Pressure		52mm
Part No.	Range	Voltage
350030005	0 - 25bar	12V
350030005 + Voltage Dropping Resistor p/n N05801180		24V

Note: 3 pin plug kit part no. 240.030 recommended. Not included in kit.

With ISO symbol.

2500Kpa = 25bar = 406psi

Dropping resistor 24 - 12V

Senders		Insulated Return 2 terminal
Part No.	Description	Specifications
360081038003C	0 - 25 bar 400 psi single station insulated return	1/8"-27 NPTF

For thread adaptors see page 61. For additional pressure senders see page 54.

For calibration specs, see page 88.

TEMPERATURE GAUGES, electrical

Suitable for most vehicles and machines.
 Illumination 12V or 24V included.
 For matching sender units refer to page 60.

Temperature Gauge - Water		52mm	
Part No.	Range	Size	Voltage
310030002	40 - 120°C	52mm	12V
310040002	40 - 120°C	52mm	24V

Note: 3 pin plug kit part no. 240.030 recommended. Not included in kit.
 With ISO symbol.
 40 - 120°C = 100 - 250°F

Senders				
Part No.	Range	Thread	Terminal	Body Type
320.002	40 - 120°C	1/8"-27NPTF	button	a
320.093	40 - 120°C	1/8"-27NPTF	M4 thread	b
320.022	40 - 120°C	1/2"-14NPTF	spade	c
320.004	40 - 120°C	M16x1.5mm	button	a

Note: 40 - 120°C = 100 - 250°F
 For thread adaptors see page 61. For calibration specs, see page 88.

Temperature Gauge - Engine Oil		52mm	
Part No.	Range	Size	Voltage
310030003	50 - 150°C	52mm	12V
310040003	50 - 150°C	52mm	24V

Note: 3 pin plug kit part no. 240.030 recommended. Not included in kit.
 With ISO symbol.
 50 - 150°C = 120 - 300°F

Sender				
Part No.	Range	Thread	Terminal	Body Type
320.021	50 - 150°C	1/8"-27NPTF	button	a
320.028	50 - 150°C	1/8"-27NPTF	button	d
320.092	50 - 150°C	1/8"-27NPTF	M4 thread	b
320.010	50 - 150°C	M12x1.5mm	button	a
320.007	50 - 150°C	M14x1.5mm	spade	e
320.072	50 - 150°C	1/8"-27NPTF	M4 thread	f

Note: 3 pin plug kit part no. 240.030 recommended. Not included in kit.
 50 - 150°C = 120 - 300°F
 For calibration specs, see page 88.

Temperature Gauge - Transmission Oil		52mm	
Part No.	Range	Size	Voltage
310030004	60 - 200°C	52mm	12V
310040004	60 - 200°C	52mm	24V

Note: 3 pin plug kit part no. 240.030 recommended. Not included in kit.
 With ISO symbol.
 60 - 200°C = 140 - 392°F

Sender				
Part No.	Range	Thread	Terminal	Body Type
320.006	60 - 200°C	1/8"-27NPTF	button	a
320.020	60 - 200°C	1/8"-27NPTF	button	e

For calibration specs, see page 88.



a.



b.



c.



d.



e.



f.





Thermocouple 320.714

TEMPERATURE GAUGES, mechanical

Suitable for most vehicles and machines.

Process connection is 1/8"-27NPTF threaded removable thermowell.

Temperature is transmitted via capillary tube.

Coil up excess capillary tubing - do not cut to shorten!

Illumination 12V included. For 24V application use globe part no. 240.053.

Temperature Gauge		52mm
Part No.	Range	Capillary Length
180035002	40 - 120°C	1600mm
180035004	40 - 120°C	2600mm
180035005	40 - 120°C	4000mm
180035006	40 - 120°C	6000mm
180035008	50 - 150°C	2600mm

PYROMETER, electrical

Suitable for most exhaust systems.

Thermocouple connection is by 1/4"-18NPTF compression fitting.

Illumination 12V included.

For 24V application use dropping resistor part no. N05801180

and globe part no. 240.053.

Pyrometer - Electric Kit		52mm
Part No.	Range	Voltage
397015003	0 - 900°C (37.6mV@900°C)	12V

Complete kit - consisting of instrument, thermocouple, 5m loom & weld boss.

Note: Cutting or adding length of loom will not effect calibration.

Spare Parts for 397 015 003 Pyrometer Kit

Part No.	Description
320.059	Weld boss 1/4"-18 NPTF
240.035	Loom, 5 meter (loom length can be altered, see above note)
310035001	Instrument 0 - 900°C (37.6mv) 52mm
320.714	Thermocouple 1/4" NPTF non bonded junction "K" type
800005002	Globe & Socket 12V (800005003 Globe & Socket 24V not incl.)

Note: p/n 320.714 probe length = 62 mm, adjustable. Loom length ~ 500 mm

AMMETERS, with internal shunt

Suitable for most engines which requires battery charging system, monitoring.
Voltage independent - suitable for 12V or 24V.

Ammeters with internal shunt are easily identified by the heavy duty threaded terminals. Heavy duty wire must be used for wiring.

Illumination 12V included. For 24V application use globe #240.053.

Ammeter with Internal Shunt		52mm
Part No.	Range	Voltage
190037002	60-0-60 amp	12V
190037003	100-0-100 amp	12V



VOLTMETERS

Suitable for all engines and machines.

Monitors charge and battery condition.

Dial colour coded.

Illumination 12V or 24V included.

Voltmeter		52mm
Part No.	Range	Voltage
332030001	8 - 16V	12V
332040001	18 - 32V	24V

Note: 2 pin plug kit part no. 240.031 recommended. Not included in kit.
With ISO symbol.



HOURMETER

Suitable for all vehicles and machines.

Overall Dimension 53 X 32mm.

Hourmeter			
Part No.	Range	Size	Voltage
331.534	0 - 99999.9hrs	37mm x 25mm	10/80V



HOURMETER, LCD (RE-SETTABLE)

Hourmeter			
Part No.	Range	Illumination	Voltage
331.535	0 - 99999.9hrs	Not illuminated	10/277V

Note - Connections not polarity specific.



HOURMETERS, electrical

Suitable for all vehicles and machines.

Available with 360° minute hand sweep or as hour counters only.

12V globe included.



331032004

Hourmeter - Black bezel			52mm
Part No.	Range	Illumination	Voltage
331032004	0 - 99999.9hrs	Non-Illuminated	12V



331032001

Hourmeter - Black bezel			52mm
Part No.	Range	Illumination	Voltage
331032001	0 - 99999.9hrs	Not illuminated	12V
331810012004	0 - 99999.9hrs	Illuminated	12V
331810012007	0 - 99999.9hrs	Illuminated	24V



331.601

Hourmeters - Counter type - Black bezel			52mm
Part No.	Range	Illumination	Voltage
331.601	0 - 99999.9hrs	Not illuminated	10/80V

(3-hole mounting, Flange 71mm)



331.602

Hourmeter - Counter type - With Operation Indicator - Chrome bezel			52m
Part No.	Range	Illumination	Voltage
331.602	0 - 99999.9hrs	Not illuminated	10/80V



331.600

Hourmeter - Counter type - With Operation Indicator - Black bezel			52m
Part No.	Range	Illumination	Voltage
331.600	0 - 99999.9hrs	Not illuminated	10/80V

PRT TACHOMETERS

PRT Tachometers

Part No.	Description	Colour	Voltage
333.011	PRT tacho 10,000rpm Ignition	Black	12V
333.012	PRT tacho 10,000rpm Ignition	White	12V

Features:

- 4,6 & 8 cyl settings
- Column Mount
- 110mm gauge face.
- Adjustable Shift Light



SPEEDBOAT KIT

Speedboat Kit 12v - Uses the USA ohms senders

Part No.	Description
240.817C	White / Chrome 6 Gauge Speedboat Kit 85mm Tacho and Pitot Speedo and 52mm small gauges.

Note: No senders included.

- Oil 360.050 (240-33 ohms)
- Temp 320.107 (450-30 ohms)
- Fuel 220.005 (240-33 ohms)
- Pitot tube assembly 170.702

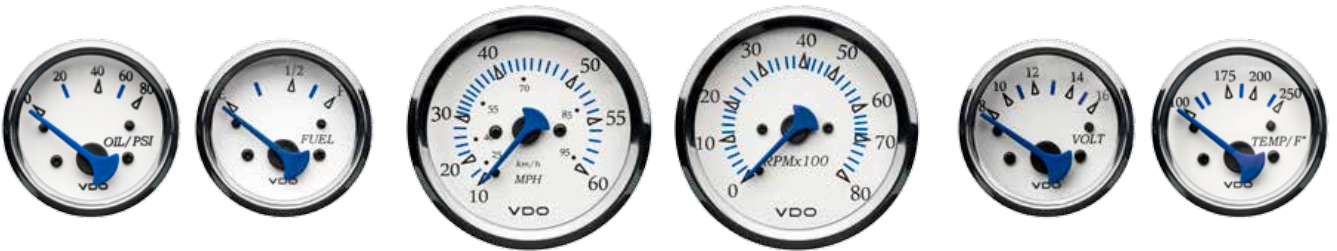

COCKPIT TITANIUM

QUALITY

Gauges are designed and based on the proven & successful VDO 'Cockpit Vision' platform.

ACCURACY

World class instrument technology for accuracy and performance.

APPEARANCE

Trioptic thru-dial illumination using fibre optic technology to illuminate pointer.

STYLE

Modern design with an eye catching sports look.

DESIGN

Utilising VDO "Spin-Lock" locking ring – eliminating panel warping & gauge rotation.



SPEEDOMETER, automotive

Illumination through dial and pointer. 12V globe included.

Field adjustable to suit 500 to 400,000 imp/km by pulse setting, or auto-calibration function through LCD readout via reset button. Total distance 999,999.9 not resettable. Speed display analogue; Odometer and trip distance LC-display trip distance 99,999.9 resettable.

Signal source Hall-effect, inductive or blocking oscillator sender units.

For 24V application use globe #240.053 (2 required).

For matching sender units refer to page 65.

Speedometer		85mm
Part No.	Range	Voltage
437.900	200km/h	12/24V

Note: 8 pin plug kit part no. 340.824 recommended. Not included in kit.



BOAT SPEEDO, marine

The Pitot Tube Speedo is designed to determine the speed of a boat over water. It consists of a pitot tube foot and hose to transfer air pressure to the speedo head system where the air pressure is converted to speed.

Speedometer - Gauge		85mm
Part No.	Range	Voltage
226.900	50mph	12V

Pitot Kit	
Part No.	Description
170.702	Pitot tube assembly black



170.702

TACHOMETER

Suitable for most petrol and diesel engines. Field programmable to suit 4, 6 or 8 cyl./4 stroke ignition and alternator pick-up (terminal "W"). Single phase, not suitable for star point or magneto system.

For Standard Points Ignition system use a 1 Amp diode in series with the signal from the negative side of the ignition coil (Diode cathode towards the Tacho input signal, terminal 4).

Illumination 12V included.

Tachometer		85mm
Part No.	Range	Voltage
333.900	8000rpm	12V

Note: 8 pin plug kit part no. 340.824 recommended. Not included in kit.



FUEL GAUGE, electrical

Suitable for most petrol, diesel fuel, and LPG systems.

Illumination 12V included.

For matching sender units refer to page 62.

Fuel Gauge			
Part No.	Range	Size	Voltage
310.900	Empty-Full	52mm	12V

Note: 3 pin plug kit part no. 240.030 recommended. Not included in kit.
For tank units with 3-180 ohms resistance.
Without ISO symbol.



Sender - Adjustable Float Arm		
Part No.	Specifications	Length
220.003	3 - 184 ohms	150 - 600mm

Note: Mounting kit part no. N05801432 not included in kit.

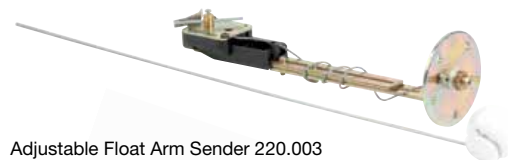

Adjustable Float Arm Sender 220.003

Reed Switch Sender Fuel & Water

Just for 3 - 180 Ohms gauges.

See complete listing of reed switch senders on page 62.

Note: Mounting kit part no. N05801432 not included in kit.



Reed Switch Sender



VOLTMETER

Suitable for all engines and machines.
 Monitors charge and battery condition.
 Dial colour coded.
 Illumination 12V or 24V included.

Voltmeter		52mm
Part No.	Range	Voltage
332.900	8-16V	12V

Note: 2 pin plug kit part no. 240.031 recommended. Not included in kit.
 With ISO symbol.

TURBO CHARGER GAUGE, mechanical



Suitable for petrol vehicles.
 Supplied with nut and cone to suit 3/16" PVC tubing.
 Illumination 12V included. Use air restrictor supplied with gauge to avoid air pulsation.

Turbo Charger Gauge		52mm
Part No.	Range	Size
150.900	-30" Hg/+25psi	52mm

Hg = Negative 30 inches of vacuum of mercury.

Note: Use airline kit 230.012 or 230.013
 Air Restrictor: 10027



Oil line kit 230.012



Nut and cone 230.008



Engine fitting 230.024



Nut and cone 230.025

Accessories

Part No.	Description
230.012	1.8m fitting kit - 3/16" PVC tubing & engine fitting
230.013	5m fitting kit - 3/16" PVC tubing & engine fitting
230.008	Nut and cone for 3/16" PVC tubing, M12x1.5 thread
230.024	Engine fitting 1/8"-27NPTF male, 3/16" PVC tubing
230.025	Nut and cone 1/8"-27NPTF nut

PRESSURE GAUGES, electrical

Oil Pressure - Engine Oil		52mm	
Part No.	Range	Size	Voltage
350.900	0 - 80psi	52mm	12V
350.901	0-5 Bar	52mm	12V

Note: 3 pin plug kit part no. 240.030 recommended. Not included in kit.
With ISO symbol.



Sender		
Part No.	Range	Thread
360.001	0 - 80psi (0-5Bar)	1/8"-27NPTF

For calibration specs, see page 88.



Sender 360.001

TEMPERATURE GAUGES, electrical

Suitable for most vehicles and engines.

Illumination 12V and 24V included.

For matching sender units refer to page 60.

Temperature Gauge - Water			
Part No.	Range	Size	Voltage
301.900	100 - 250°F	52mm	12V

Note: 3 pin plug kit part no. 240.030 recommended. Not included in kit.
With ISO symbol.
100 - 250F = 40 - 120°C



Sender				
Part No.	Range	Thread	Terminal	Body Type
320.002	100 - 250°F	1/8"-27NPTF	button	a
320.093	100 - 250°F	1/8"-27NPTF	M4 thread	b
323.801/005/001	100 - 250°F	1/8"-27NPTF	button	a
320.022	100 - 250°F	1/2"-14NPTF	spade	c
323801001006K	100 - 250°F	M14x1.5mm	spade	c
320.004	100 - 250°F	M16x1.5mm	button	a

Note: 40 - 120°C = 100 - 250°F

For calibration specs, see page 88.

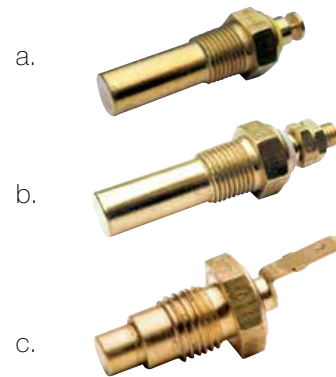

TEMPERATURE GAUGES, electrical

Suitable for most vehicles.

Illumination 12V included.

For more matching sender units refer to page 60.

Adaptors are listed on page 61.



a.



b.



c.



Temperature Gauge - Water			52mm
Part No.	Description	Specifications	Voltage
301.901	Water temp. symbol on dial	40 - 120°C 287-23 ohms	12V

Note: 3 pin plug kit part no. 240.030 recommended. Not included in kit.

Temperature Sender				
Part No.	Range	Thread	Terminal	Body Type
320.002	40 - 120°C	1/8"-27NPTF	button	a
320.093	40 - 120°C	1/8"-27NPTF	M4 thread	b
320.022	40 - 120°C	1/2"-14NPTF	spade	c
320.004	40 - 120°C	M16x1.5mm	button	a

Note: 40 - 120°C = 100 - 250°F

For calibration specs, see page 88.



d.



e.



f.



Temperature Gauge - Oil			52mm
Part No.	Description	Specifications	Voltage
301.902	Engine oil temp. symbol on dial	50 - 150°C 323-18 ohms	12V

Note: 3 pin plug kit part no. 240.030 recommended. Not included in kit.

Temperature Sender				
Part No.	Range	Thread	Terminal	Body Type
320.021	50 - 150°C	1/8"-27NPTF	button	a
320.028	50 - 150°C	1/8"-27NPTF	button	d
320.092	50 - 150°C	1/8"-27NPTF	M4 thread	d
320.010	50 - 150°C	M12x1.5mm	button	a
320.007	50 - 150°C	M14x1.5mm	spade 90°	e
320.072	50 - 150°C	1/8"-27NPTF	M4 thread	f

Note: 50 - 150°C = 120 - 300°F

For calibration specs, see page 88.

COCKPIT WHITE

Cockpit White offers an alternative appearance to conventional black face dials, developed from VDO's strength and commitment to the automotive industry to provide a low cost range of gauges suited to a broad range of applications. These reliable gauges feature easy to read flood lit dial illumination for a fantastic look.

TACHOMETERS

Field programmable to suit 4, 6 or 8 cylinder, four stroke petrol engines with coil pickup or alternator pick-up (terminal "W") on diesel applications. Illumination 12V included. Single phase, not suitable for star point, inductive, generator or magneto system.

Tachometer - Electronic

Part No.	Range	Size	Voltage
333.100	0 - 8000rpm	100mm	12V
333.255	0 - 7000rpm	85mm	12V

Note: 8 pin plug kit part no. 340.824 recommended. Not included in kit.



SPEEDOMETERS, automotive

Illumination through dial and pointer. 12V globe included. Field adjustable to suit 500 to 400,000 imp/km by pulse setting, or auto-calibration function through LCD readout via reset button. Total distance 999,999.9 not resettable. Speed display analogue; Odometer and trip distance LC-display trip distance 99,999.9 resettable. Signal source Hall-effect, inductive or blocking oscillator sender units. For 24V application use globe #240.053 (2 required). For matching sender units refer to page 60.

Speedometer - Electronic

Part No.	Range	Size	Voltage
437.202	0 - 120mph	85mm	12/24V
437.100	0 - 280km/h	100mm	12/24V

Note: 8 pin plug kit part no. 340.824 recommended. Not included in kit.

BOAT SPEEDO, marine

The Pitot Tube Speedo is designed to determine the speed of a boat over water. It consists of a Pitot tube foot and hose to transfer air pressure to the speedo head system where the air pressure is converted to speed.

Speedometer - Pitot Tube

Part No.	Range	Size	Voltage
170.701	50Kn	85mm	12V

Accessories

Part No.	Description
170.702	Pitot tube assembly, black



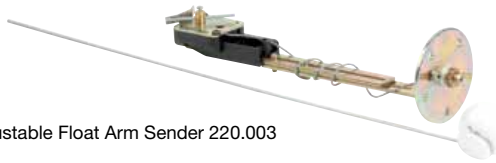

Adjustable Float Arm Sender 220.003



Flange Mounting Kit N05801432

FUEL GAUGE, electrical

Suitable for use with most petrol and diesel fuel.
Illumination 12V and 24V included.

Fuel Gauge			52mm
Part No.	Range	Size	Voltage
301.216	Fuel gauge float arm	3 - 180 ohms	12V

Note: 3 pin plug kit part no. 240.030 recommended. Not included in kit.

Sender - Adjustable Float Arm

Part No.	Specifications	Length
220.003	3 - 180 ohms	150 - 600mm

Note: Mounting kit part no. N05801432 not included in kit.

Accessories

Part No.	Description	PCD
N05801432	Flange mounting kit	54mm

Note: More Accessories, refer to pages 62.

PRESSURE GAUGE, electrical

Suitable for most vehicles.
Illumination 12V included.
Adaptors are listed on page 61.



Sender 360.001

Electric Pressure Gauge - 80psi / 500Kpa		52mm
Part No.	Specifications	Voltage
350.240	80psi (500Kpa)	12V

Note: 3 pin plug kit part no. 240.030 recommended. Not included in kit.

Sender			0-180 ohms
Part No.	Range	Thread	Terminal
360.001	500Kpa	1/8"-27NPTF	Spade
360.004	500Kpa	1/4"-18NPTF	Button
360.016	500Kpa	1/8"-28BSBT	Button
360.018	500Kpa	1/8"-27NPTF	M4 thread

Refer to your engine manufacturers manual for correct oil pressure ratings.

Note: 500 Kpa = 5 Bar = 72.5 psi 700 Kpa = 7 Bar = 101.5 psi
1000 Kpa = 10 Bar = 145 psi 2800 Kpa = 28 Bar = 406 psi

PRESSURE GAUGE, mechanical

Suitable for most vehicles.
 Supplied with nut and cone for 3/16" PVC tubing.
 Illumination 12V included.

Electric Pressure Gauge			52mm
Part No.	Specifications	Voltage	
150.202	0 - 100psi	12V	

Accessories	
Part No.	Description
230.012	1.8m fitting kit - 3/16" PVC tubing & engine fitting
230.013	5m fitting kit - 3/16" PVC tubing & engine fitting
230.008	Nut and cone for 3/16" PVC tubing, M12x1.5 thread
230.024	Engine fitting 1/8"-27NPTF male, 3/16" PVC tubing
230.025	Nut and cone 1/8"-27NPTF nut



Oil line kit 230.012



Nut and cone 230.008



Engine fitting 230.024



Nut and cone 230.025

TURBO CHARGER GAUGE, mechanical

Suitable for vehicles.
 Supplied with nut and cone to suit 3/16" PVC tubing.
 Illumination 12V included.

Turbo Charger Gauge			52mm
Part No.	Description	Specification	
150.206	"TURBO" on dial	-30"HG/+25psi	

Hg = Negative 30 inches of vacuum of mercury.

Note: Use airline kit 230.012 or 230.013
 Accessories below.
 Air Restrictor: 10027

Accessories	
Part No.	Description
230.012	1.8m fitting kit - 3/16" PVC tubing & engine fitting
230.013	5m fitting kit - 3/16" PVC tubing & engine fitting
230.008	Nut and cone for 3/16" PVC tubing, M12x1.5 thread

Note: For more Accessories, refer to pages 61.



Engine fitting 230.024



Nut and cone 230.025

VOLTMETER

Suitable for all engines.
 Illumination 12V or 24V included.

Voltmeter				52mm
Part No.	Description	Range	Voltage	
332.241	Voltmeter	8 - 16V	12V	

Note: 2 pin plug kit part no. 240.031 recommended. Not included in kit.



EXHAUST TEMPERATURE / PYROMETER, electrical

Suitable for most exhaust systems. Thermocouple connection is by 1/4"- NPTF compressing fitting.

This kit features the VDO "Spin-lock" fastening system illumination 12V included.



Thermocouple 320.714

Pyrometer - Electrical Kit		52mm
Part No.	Range	Voltage
310.240	250 - 1600°F	12V

Complete kit - consisting of instrument, thermocouple, 5m loom.

Spare Parts for 310.240 exhaust temperature/pyrometer kit	
Part No.	Description
320.714	Thermocouple 1/4" NPTF non bonded junction "K" type
240.035	Loom, 5m
320.059	Weld boss 1/4" - 1/8" NPTF

Note: p/n 320.714 probe length = 62 mm, adjustable. Loom length ~ 500 mm

TEMPERATURE GAUGE, electrical

Suitable for most vehicles.

Illumination 12V included.

For more matching sender units refer to page 60.

Adaptors are listed on page 61.

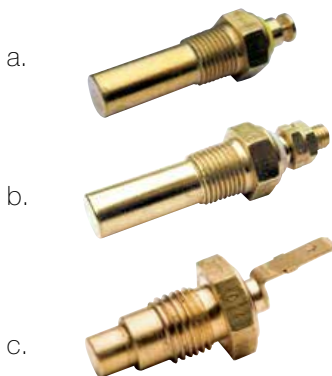

Temperature Gauge - Water		52mm
Part No.	Range	Voltage
310.239	100 - 250°F	12V

Note: 3 pin plug kit part no. 240.030 recommended. Not included in kit.

Sender				
Part No.	Range	Thread	Terminal	Body Type
320.002	100 - 250°F	1/8"-27NPTF	button	a
320.093	100 - 250°F	1/8"-27NPTF	M4 thread	b
320.022	100 - 250°F	1/2"-14NPTF	spade	c
320.004	100 - 250°F	M16x1.5mm	button	a

Note: 40 - 120°C = 100 - 250°F

For calibration specs, see page 88.

COCKPIT DIGITAL

TURBO GAUGE, digital

Turbo Gauge		Range	52mm
Part No.	Description		Voltage
350.410	Gauge - 0 to 30 Psi		12 V



Pressure Sender - Air			
Part No.	Range	Thread	Ohms
360081032025C	0 - 2 Bar (30)	1/8"-27NPTF	10 - 180
360081032011C	0 - 2 Bar (30)	M 12x1.5	10 - 180

AIR FUEL RATIO GAUGE, digital

Suitable for monitoring engine performance.
 Rich - Hard acceleration
 Mid - Optimised engine response to acceleration
 Lean - Better fuel economy

Air Fuel Ratio Gauge			52mm
Part No.	Range	Input Range	Voltage
301.401	Lean - Rich	0 - 1V (narrow band)	12V
301.440	Lean - Rich	0 - 5V (wide band)	12V



Air Fuel Ratio sender			52mm
Part No.	Range	Output Range	
A2C59513091	Oxy Sensor	0 - 1V	

PRESSURE GAUGE, digital

Suitable for most vehicles.

Pressure Gauge - Oil			52mm
Part No.	Specification		Voltage
350.401	5 Bar		12V

Note: Not recommended for petrol.



Sender - 500Kpa			10-180 ohms
Part No.	Range	Thread	Terminal
360.001	500Kpa	1/8"-27NPTF	Spade
360.004	500Kpa	1/4"-18NPTF	Button
360.016	500Kpa	1/8"-28BSBT	Button
360.018	500Kpa	1/8"-27NPTF	M4 thread

Note: 500 Kpa = 5 Bar = 72.5 psi
 Refer to your engine manufacturers manual for correct oil pressure ratings.
 For thread adaptors see page 61. For additional pressure senders see page 54/55.
 For calibration specs, see page 88.



Sender 360.001

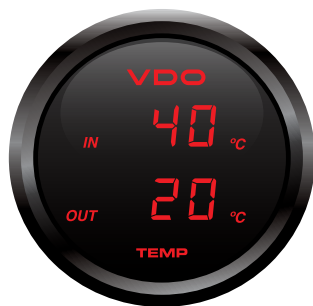
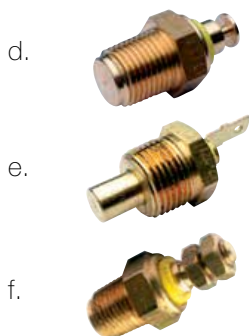
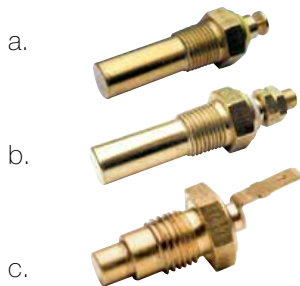

TEMPERATURE GAUGES, digital

Digital Water Temperature Gauges (40-120°C) & Digital Oil Temperature Gauges (50-150°C) display an LED light which is clear and easy to see in any time of the day or night.

Temperature Gauge - Water			52mm
Part No.	Range	Voltage	
310.401	40 - 120°C	12V	

Temperature Sender				
Part No.	Range	Thread	Terminal	Body Type
320.002	40 - 120°C	1/8"-27NPTF	button	a
320.093	40 - 120°C	1/8"-27NPTF	M4 thread	b
320.022	40 - 120°C	1/2"-14NPTF	spade	c
320.004	40 - 120°C	M16x1.5mm	button	a

Note: 40 - 120°C = 100 - 250°F
For calibration specs, see page 88.

Temperature Gauge - Oil			52mm
Part No.	Range	Voltage	
310.701	50 - 150°C	12V	

Temperature Sender				
Part No.	Range	Thread	Terminal	Body Type
320.021	50 - 150°C	1/8"-27NPTF	button	a
320.028	50 - 150°C	1/8"-27NPTF	button	d
320.092	50 - 150°C	1/8"-27NPTF	M4 thread	d
320.010	50 - 150°C	M12x1.5mm	button	a
320.007	50 - 150°C	M14x1.5mm	spade 90°	e
320.072	50 - 150°C	1/8"-27NPTF	M4 thread	f

Note: 50 - 150°C = 120-300°F
For calibration specs, see page 88.

Inside-Outside Temp Gauge Kit			52mm
Part No.	Description	Range	Voltage
310.006	Inside/Outside Temp gauge and senders	-20 - 60°C	12V

Note: Inside Sender provided - 5mm eyelet.
Note: Outside Sender provided - 5mm eyelet.

VOLTMETER, digital

Suitable for most engines/vehicles where battery and charging systems need to be monitored.

Voltmeter		52mm
Part No.	Description	Voltage
332.401	Gauge	8 - 18V



Dual Voltmeter		52mm
Part No.	Description	Voltage
332.540	Gauge	8 - 18V



PYROMETER, digital

Pyrometer Kit		52mm
Part No.	Description	Voltage
310.520PK	Gauge - 100 C to 1200 C	12 V

310.520PK (Kit)	
Part No.	Description
310.520	Gauge
320.714	Sender
240.035	Loom
320.059	Weld Boss

Spare Parts for 310.240 exhaust temperature/pyrometer kit

Part No.	Description
320.714	Thermocouple 1/4" NPTF non bonded junction "K" type
240.035	Loom, 5m
320.059	Weld boss 1/4" - 1/8" NPTF

Note: p/n 320.714 probe length = 62 mm, adjustable. Loom length ~ 500 mm

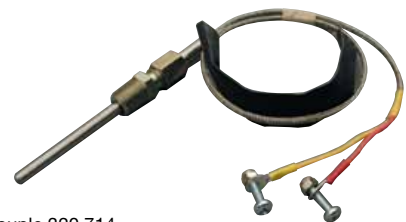

Thermocouple 320.714

Cylinder Head Temp Gauge Kit		52mm
Part No.	Description	Voltage
310.901	0-300c Cylinder Head Temp Gauge 10mm eyelet sender incl in kit.	12V



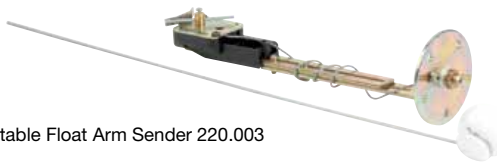

Adjustable Float Arm Sender 220.003

FUEL GAUGES, digital

Fuel Gauge	Resistance Range	52mm
Part No.		Voltage
301.530	3 - 180 or 0 - 90 Ohms	12 V

Sender - Adjustable Float Arm

Part No.	Specifications	Length
220.003	3 - 180 ohms	150 - 600mm

Note: Mounting kit part no. N05801432 not included in kit.

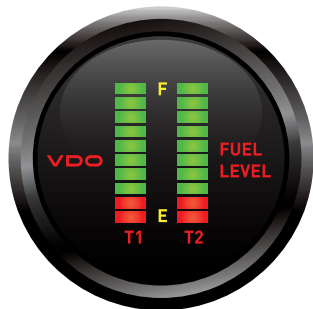

Dual Fuel Gauge	Resistance Range	52mm
Part No.		Voltage
301.550	3 - 180 or 0 - 90 Ohms	12 V

Note: LPG - As long as resistance is compatible.



TACHOMETER, digital

Suitable for most petrol engines. Field programmable to suit 4, 6 or 8 cyl./4 stroke ignition.

Tachometer	52mm	
Part No.	Specification	Voltage
333.003	10K RPM	12V

MARINE

TACHOURMETER

Tachourmeter				
Part No.	Colour Dial/Bezel	Range	Voltage	
A2C59512391	Black	0 - 4000 RPM	12/24V	Alternator Ignition Coil Generator Inductive
A2C59512394	Black	0 - 7000 RPM	12/24V	Alternator Ignition Coil Generator Inductive
A2C59512397	White	0 - 4000 RPM	12/24V	Alternator Ignition Coil Generator Inductive
A2C59512399	White	0 - 6000 RPM	12/24V	Alternator Ignition Coil Generator Inductive



Marine

TEMPERATURE GAUGES

Temperature Gauge - Water					52mm
Part No.	Colour Dial/Bezel	Range	Voltage	Ohms Range	
A2C59514170	Black	40 - 120°C	12/24V	282 - 22 Ohms	
A2C59514237	White	40 - 120°C	12/24V	282 - 22 Ohms	

Note: 40 - 120°C = 100 - 250°F
38.6 Ohms = 100C



Temperature Gauge - Engine					52mm
Part No.	Colour Dial/Bezel	Range	Voltage	Ohms Range	
A2C59514160	Black	50 - 150°C	12/24V	323 - 18 Ohms	
A2C59514231	White	50 - 150°C	12/24V	323 - 18 Ohms	

Note: 50 - 150°C = 120 - 300°F
62.2 Ohms = 100C



PYROMETER GAUGES

Pyrometer Gauge					52mm
Part No.	Colour Dial/Bezel	Range	Voltage	mV Range	
A2C59512332	Black	100 - 900°C	12/24V	4.04 - 37.5 mV	
A2C59512333	White	100 - 900°C	12/24V	4.04 - 37.5 mV	

Note: 100 - 900°C = 210 - 1650°F





PRESSURE GAUGES

Pressure Gauge Turbo 2 Bar

Part No.	Colour Dial/Bezel	Range	Voltage	Ohms Range
A2C59514149	Black	0 - 2 Bar	12/24V	10 - 183 Ohms
A2C59514225	White	0 - 2 Bar	12/24V	10 - 183 Ohms

Note: 0 - 2 Bar = 0 - 28 Psi



Pressure Gauge Engine Oil

52mm

Part No.	Colour Dial/Bezel	Range	Voltage	Ohms Range
A2C59514123	Black	0 - 5 Bar	12/24V	0 Bar = 10 5 Bar = 183
A2C59514211	White	0 - 5 Bar	12/24V	0 Bar = 10 5 Bar = 183

Note: 0 - 5 Bar = 0 - 72 Psi



Pressure Gauge Engine Oil

52mm

Part No.	Colour Dial/Bezel	Range	Voltage	Ohms Range
A2C59514111	Black	0 - 10 Bar	12/24V	0 Bar = 10 10 Bar = 183
A2C59514199	White	0 - 10 Bar	12/24V	0 Bar = 10 10 Bar = 183

Note: 0 - 10 Bar = 0 - 150 Psi



Pressure Gauge Transmission

52mm

Part No.	Colour Dial/Bezel	Range	Voltage	Ohms Range
A2C59514136	Black	0 - 25 Bar	12/24V	0 Bar = 10 25 Bar = 183
A2C59514206	White	0 - 25 Bar	12/24V	0 Bar = 10 25 Bar = 183

Note: 0 - 25 Bar = 0 - 400 Psi



GPS SPEED GAUGES

GPS Speedo

125mm

Part No.	Colour Dial/Bezel	Range	Voltage
A2C59501782	Black	0-35 kmh/mph/knots	12V
A2C59501781	Black	0-70 kmh/mph/knots	12V

Specifications:

- Mounting hole is 110mm
- Embedded GPS antenna
- Front side protection rating IP67
- CAN capability (NMEA 2000)
- Pointer for analog indication of Speed over Ground (SOG)
- Programmable speed alarm

FUEL GAUGES

Fuel Gauge		52mm		
Part No.	Colour Dial/Bezel	Range	Voltage	Ohms Range
A2C59514082	Black	0 - 1	12/24V	Empty = 3 Full = 180
A2C59514184	White	0 - 1	12/24V	Empty = 3 Full = 180



Fuel Gauge Tubular Type				
Part No.	Colour Dial/Bezel	Range	Voltage	Ohms Range
A2C59514088	Black	0 - 1/1	12/24V	Empty = 110/50 Full = 2
A2C59514182	White	0 - 1/1	12/24V	Empty = 110/50 Full = 2

VOLTMETERS

Voltmeter			52mm
Part No.	Colour Dial/Bezel	Range	Voltage
A2C59512545	Black	8 - 16V	12V
A2C59512546	White	8 - 16V	12V
A2C59512458	Black	8 - 32V	24V
A2C59512459	White	8 - 32V	24V



MULTIFUNCTION GAUGES

4 in one Gauges			110mm
Part No.	Colour Dial/Bezel	Range	Voltage
A2C59514265	Black	Volt 8 - 16V Pressure 0 - 5 Bar Temp. 40 - 120°C Fuel E - F	12V
A2C59514266	White	Volt 8 - 16V Pressure 0 - 5 Bar Temp. 40 - 120°C Fuel E - F	12V





Cabin Version



Trailer Version



SG Sensor



KIMAX I

Kimax I - Cabin

Part No.	Description
X10732002003	Cabin Version with 1 Sensor
X10732002001	Cabin Version with 2 Sensors

Kimax I - Trailer

Part No.	Description
X10732002004	Trailer Version with 1 Sensor
X10732002002	Trailer Version with 2 Sensors

KIMAX II

Kimax II - Cabin

Part No.	Description
101.313	Cabin Instrument for multiple applications.

Communication

Kimax II Radio

Air Input 2

Air Input 1

SG Sensors

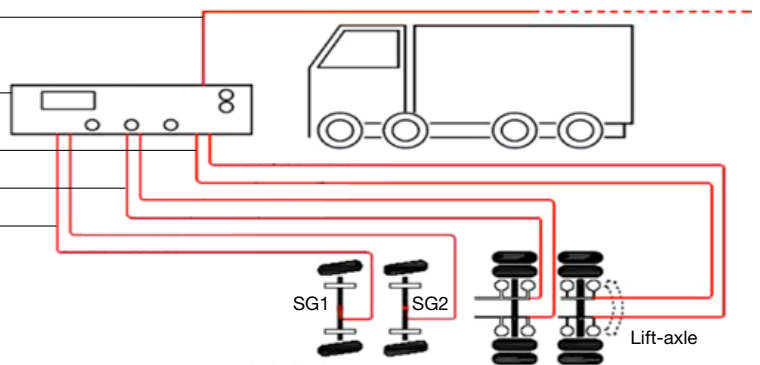

CENTRAL LOCKING

KEYLESS ENTRY, remote controlled

This part converts cars with central locking to keyless entry. It has a great use for cars that have lost or broken factory remotes.

This kit contains 2 remote controls, indicator outputs, full relay outputs, vacuum control selectable and a boot release output.

Universal remote keyless entry system		
Part No.	Description	Voltage
880.770	Kit	12V



KEYLESS ENTRY with alarm / immobiliser

This part converts cars with central locking to keyless entry. It has a great use for cars that have lost or broken factory remotes.

This kit contains universal remote control, immobilizer output and relay, shock sensor, also a door, boot and bonnet protection circuit, 2 black remote controls, 1 Pink remote control, indicator outputs, full relay outputs, vacuum control selectable, boot release output and a battery back up siren.

Universal remote keyless entry system with Alarm		
Part No.	Description	Voltage
900.550	Kit with alarm	12V



REMOTE CONTROLLED CENTRAL LOCKING KIT

The VDO Remote Controlled Central Locking Kit is a universal kit which converts standard locks to transmitter operated central locking. Features indicator lamps output and an optional starter kill (use part no. 880.012), and boot release function (additional relays required.)

Central Locking Kit		12V
Part No.	Description	Specifications
900.705	Remote controlled	4 Actuators Central locking kit (key)



CENTRAL LOCKING KIT

The VDO Central Locking Kit is a universal kit which converts standard locks to key operated central locking, with master actuators for both front doors. This unit can be integrated with most remote controlled alarms and immobilisers for full keyless entry. The kit includes all necessary hardware, 4 actuators, wiring loom and control box. Can be integrated to VDO immobilisers part number: 900.600

Central Locking Kit		12V
Part No.	Description	Specifications
880.700	Central locking kit for	4 Actuators existing remote controls

Accessories		12V
Part No.	Description	
880.003	Slave locking actuator 2 wire	
880.004	Master locking actuator 5 wire	
880.012	Electric boot release kit 12V	
880.020	Remote Control suits 880.705 - 900.505 - 900.600 - 900.705	



Slave locking actuator 880.003

SPEAKERS



Pair of Speakers

Part No.	Description	Watts
101.350	Pair of speakers 100mm 2 way	50 Watts

2-way coaxial system
 2 Black grilles with VDO logo and zinc plating pre-treatment
 Diameter: 100 mm
 Power handling: 12 – 50 Watts
 Frequency range: 120 – 18,000 Hz
 Sensitivity dB/W/m: 90
 Mounting kit
101.350 is labelled HP1021



Pair of Speakers

Part No.	Description	Watts
101.351	Pair of speakers 130mm 2 way	60 Watts

2-way coaxial system
 2 Black grilles with VDO logo and zinc plating pre-treatment
 Diameter: 130 mm
 Power handling: 15 – 60 Watts
 Frequency range: 100 – 18,000 Hz
 Sensitivity dB/W/m: 89
 Mounting kit
101.351 is labelled HP1321



Pair of Speakers

Part No.	Description	Watts
101.352	Pair of speakers 130mm 2 way white grilles	60 Watts

2-way coaxial system
 2 white grilles with VDO logo and zinc plating pre-treatment
 Diameter: 130 mm
 Power handling: 15 – 60 Watts
 Frequency range: 100 – 18,000 Hz
 Sensitivity dB/W/m: 88
 Mounting kit
101.352 is labelled HPW1321



Pair of Speakers

Part No.	Description	Watts
101.353	Pair of speakers 130mm 2 way white grilles	150 Watts

Pair of uniblock waterproof speakers
 ABS ABS777B with treatment against UB (ASA)
 2 speakers per box
 2 way coaxial system
 Diameter: 130 mm
 Power handling: 30 – 150 Watts
 Frequency range: 80 – 20,000 Hz
 Sensitivity dB/W/m: 87
 Mounting kit : with rubber gasket, screws and Iso cables
101.353 is labelled 051-018-011

RADIOS

Tuner (RDS) USB

Part No.	Description	Specifications	Voltage
101.270	AM/FM/USB/AUX/MP3/WMA	4 x 41W	12V
101.271	AM/FM/USB/AUX/MP3/WMA	4 x 15W	24V

1 Din, 188x58.5x114.7, RDS Clock, Battery Back Up. Steering Wheel Control, Front AUX input & Front USB.

101.270 is labelled TR711U
101.271 is labelled TR722U

Tuner (RDS) USB, Bluetooth

Part No.	Description	Specifications	Voltage
101.264	AM/FM/USB/AUX/MP3/WMA/Bluetooth	4 x 41W	12V
101.265	AM/FM/USB/AUX/MP3/WMA/Bluetooth	4 x 15W	24V

1 Din, 188x58.5x114.7, RDS Clock, Battery Back Up. Steering Wheel Control, Front AUX input & Front USB.

101.264 is labelled TR712UB
101.265 is labelled TR723UB

Tuner (RDS) USB, CD / MP3

Part No.	Description	Specifications	Voltage
101.268	AM/FM/USB/AUX/MP3/WMA/CD	4 x 41W	12V
101.269	AM/FM/USB/AUX/MP3/WMA/CD	4 x 15W	24V

1 Din, 188x58.5x114.7, RDS Clock, Battery Back Up. Steering Wheel Control, Rear AUX input & Front USB.

101.268 is labelled CD716U
101.269 is labelled CD726U

Tuner (RDS) USB, CD / MP3, DAB+, Bluetooth

Part No.	Description	Specifications	Voltage
101.266	AM/FM/DAB/USB/AUX/MP3/WMA/CD/Bluetooth	4 x 41W	12V
101.267	AM/FM/DAB/USB/AUX/MP3/WMA/CD/Bluetooth	4 x 15W	24V

1 Din, 188x58.5x114.7, RDS Clock, Battery Back Up. Steering Wheel Control, Rear AUX input & Front USB.

101.266 is labelled CDD718UB
101.267 is labelled CDD728UB

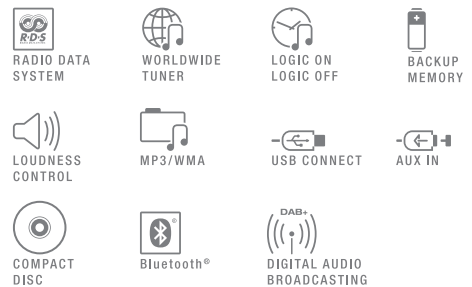
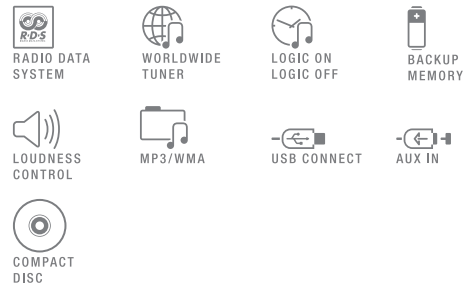
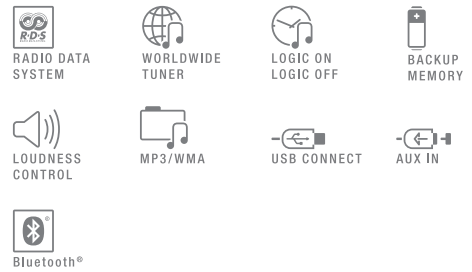
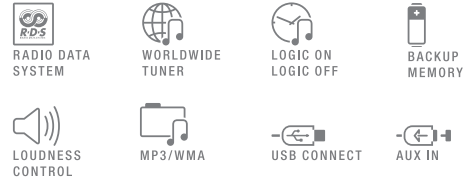



LOW WATER ALARM

The VDO Low Water Alarm Electronic Module monitors current continuity while the low water level probe is submerged in water. The location of the probe in the radiator or header tank determines the critical water level. Warning occurs within a few seconds of this level being reached. The flashing warning light and continuously activated buzzer can only be cancelled by switching off the engine. The circuit design features a functional check which is carried out every time the ignition is turned off. It also includes a delay action to avoid premature triggering.

Note: For aluminium core radiators, fit water level probe to vehicle thermostat housing.

Low Water Alarm

Part No.	Description	Voltage
410.007	Low Water Warning Kit	12/24V

Note: Kit contents - Warning light, electronic module water level probe, buzzer adaptor, soldering bush, and all wiring plugs and sockets.

Accessories

Part No.	Description	Specification
410.006	Electronic Module	110 X 67 X 35mm
230.058	Water level probe	30mm Long
230.059	Water level probe	90mm Long
230.016	Soldering Bush	
230.017	Threaded Adaptor	M14 X1.5 Round.
230.204	38mm radiator hose adaptor	38mm hose/ 1/8npt hole
230.205	1/8 npt low water probe	M14 X1.5 Round



230.204



WARNING LIGHTS

Warning Lights

Part No.	Description	Specification	Size
170.708	Red Light	Holder & 12V globe	15mm hole
170.709	Amber light	Holder & 12V globe	15mm hole
170.712	Green light	Holder & 12V globe	15mm hole
240.057	Globe	24V	
240.056	Globe	12V	



Warning buzzer base

WARNING BUZZERS

Warning Lights

Part No.	Description	Specification	Voltage
240.022	Buzzer 75db	50mA	12/24V



Push button switch 170.713

STARTER SWITCHES

Push Button Switch

Part No.	Description	Specification	Size
170.713	Push button N/O	10 amp	15mm hole
170.714	Push button N/C	10 amp	15mm hole

Note: N/O = Normally Open Contact.
N/C = Normally Closed Contact.

Brass switch 170.706



Key Switches

Part No.	Description	Specification
170.706	Brass key switch	Off - On - Start

REVERSING SCREENS

Reversing Screens

Part No.	Description
411.012	7" Dual input LCD display 12/24v
411.013	7" Quad input LCD display 12/24v
411.008	7" Colour Reversing Screen Kit with Butterfly Camera & 10mtr loom.

180mm*124mm*50mm
 Auto camera select, auto brightness
 NTSC/PAL compatible
 Built-in 12v camera power supply



411.012 Dual input
 411.013 Quad input

REVERSING CAMERAS

Reversing Cameras

Part No.	Description
411.014	12v Heavy Duty Night Vision Camera (Large)
411.015	12v Heavy Duty Night Vision Camera (Small)
411.016	12v Side View Night Vision Camera
411.017	12v Compact 'Butterfly' Camera



411.014



411.015



411.016



411.017

CAMERA EXTENSIONS CABLES

Camera Extension Cables

Part No.	Description
411.009	5 Meter
411.010	10 Meter
411.011	20 Meter

DVR

DVR

Part No.	Description
411.003	4ch Mobile DVR 12/24v



411.103

CRUISE CONTROLS

UNIVERSAL CRUISE CONTROL

Suits cable driven foot pedals.

Electronic cruise control suitable for petrol and diesel engines, automatic or manual transmission. Actuator & control box in one compact unit. Dip switch controls for quick calibration and fine tuning.



Pacesetter Cruise Control		12V
Part No.	Description	
X10397106825	Cruise control, complete kit, includes part no. 412.006 stalk switch, electric actuator, wiring loom, bowden cable.	

Accessories	
Part No.	Description
X39397106152	Clutch Switch (for Diesel engines appl.)



NEW CRUISE CONTROL KITS

Suits electronic pedals.

Features and Benefits

Features	Benefits
Electronic interface	No moving parts
Single compact module	Easy installation
Plug and play	Reliable OEM connectors including custom pedal harnesses
Model specific kits	No field calibration or adjustment required
CAN bus compatible	Will work with the latest vehicles
OEM Style control switches	Factory look
On board diagnostics	Simple and effective fault finding
No programming required	

CRUISE CONTROL APPLICATION LISTING

AUDI				
Make/Series	Year	Spec	Control Switch	VDO P/N
A3 All	2009>	Man	Stalk LH	412.100
A3 All	2009>	Man	RF sws	412.101
A3 All	2009>	DSG	Stalk LH	412.154
A3 All	2009>	DSG	RF sws	412.155

BMW				
Make/Series	Year	Spec	Control Switch	VDO P/N
1 Series	2011	1.8 Diesel	Stalk LH	412.303
1 Series	2011	1.8 Diesel	D-Shaped RF SWS	412.304

CHERY				
Make/Series	Year	Spec	Control Switch	VDO P/N
J3	2013>	All	Stalk LH	412.305
J3	2013>	All	D-Shaped RF SWS	412.306

FIAT				
Make/Series	Year	Spec	Control Switch	VDO P/N
500	2008>	All	Stalk LH	412.102
Ducato	2004-06	2.8 JTD AFT	Stalk LH	412.156
Ducato	2004-06	2.8 JTD AFT	RF sws	412.157
Ducato	2006>	All	Stalk LH	412.158
Ducato	2006>	All	RF sws	412.159
Punto	2009>	All	Stalk LH	412.307
Punto	2009>	All	D-Shaped RF sws	412.308

FORD				
Make/Series	Year	Spec	Control Switch	VDO P/N
Fiesta	2009>	All	RF sws	412.105
Fiesta	2009>	All	Stalk LH	412.162
Focus	2007-2011	CL	RF sws	412.103
Focus	2009>	XR5	Wired sws	412.104
Focus	2007-2011	CL	Stalk LH	412.160
Focus	2009>	XR5	RF sws	412.161
Focus	2011>	1.6l Man /Auto	Stalk L/H only	412.218
Ranger	2007-2011	With Airbag	OEM	412.164
Ranger	2007-2011	With Airbag	Stalk LH	412.165
Territory PX	2005>	4.0 Petrol	RF sws	412.271
Transit	2006-2012	All	RF sws	412.106
Transit	2006-2012	All	Stalk LH	412.163
Transit	2000-2006	All	Stalk LH	412.309
Transit	2000-2006	All	D-Shaped RF sws	412.310
Transit Van VM	2012>	2.2L Diesel Man/Auto	RF sws	412.234
Transit Van VM	2012>	2.2 L Diesel Man/Auto	Stalk LH	412.235

CRUISE CONTROL APPLICATION LISTING

FOTON

Make/Series	Year	Spec	Control Switch	VDO P/N
Tunland	2012>	2.8 Tdi	D-Shaped RF sws	412.311
Tunland	2012>	2.8 Tdi	Stalk LH	412.312

GREAT WALL

Make/Series	Year	Spec	Control Switch	VDO P/N
V200	2011>	Turbo-Diesel	Stalk LH	412.213
V200	2011>	DBW Tdi	RF sws	412.263
X200	2012>	DBW Tdi	Stalk LH	412.264
X200	2012>	DBW Tdi	RF sws	412.265

HINO

Make/Series	Year	Spec	Control Switch	VDO P/N
All	before June< 2011	300 series	Stalk LH	412.167
All	After June 2011>	300 series	Stalk LH	412.211
FL	2008>	500 series 24 volt	Stalk LH	412.214

HOLDEN

Make/Series	Year	Spec	Control Switch	VDO P/N
Astra AH	2006-10	Auto	Stalk LH	412.168
Astra AH	2006-10	Auto	RF sws	412.169
Astra TS	2002-2006	1.8lt All	Stalk LH	412.241
Astra TS	2002-2006	1.8lt All	RF sws	412.242
Barina	2011>	1.6 (DBW)	Stalk LH	412.170
Barina	2011>	1.6 (DBW)	RF sws	412.171
Barina Spark	2009>	1.2lt	Stalk LH	412.172
Barina Spark	2009>	1.2lt	RF sws	412.173
Colorado	2012>	2.5 & 2.8 TDi diesel	RF sws	412.360
Colorado	2012>	2.5 & 2.8 TDi diesel	LH Stalk	412.361
Colorado DX 2.5 & 2.8	June 2012>	2.5 L Diesel Man 4x2	Stalk LH	412.237
Colorado DX 2.5 & 2.8	June 2012>	2.5 & 2.8 L Diesel Man 4x2	RF sws	412.295
Combo	2006>	1.4 petrol DBW	Stalk LH	412.314
Combo	2006>	1.4 petrol DBW	D-Shaped RF sws	412.315
Jackaroo	1999 >	Auto, 3L Turbo Diesel	Stalk L/H	412.298
Jackaroo U8	1999>	3.0 Tdi	Stalk LH	412.316
Rodeo/Colorado	2007-2012	3.0 Tdi	Stalk LH	412.317
Rodeo/Colorado	2007-2012	3.0 Tdi	D-Shaped RF sws	412.318
Rodeo/Colorado	2007-2012	Alloytec V6	Stalk LH	412.319

HONDA

Make/Series	Year	Spec	Control Switch	VDO P/N
Civic	2012>	Hatch Auto only	OEM	412.243
Civic	2012>	Hatch Auto/Man.	Stalk LH	412.246
Civic	2012>	Hatch Auto/Man.	RF sws	412.247
Jazz	2008-10	All	Stalk LH	412.108
Jazz	2008-10	All	RF sws	412.109

CRUISE CONTROL APPLICATION LISTING

HYUNDAI				
Make/Series	Year	Spec	Control Switch	VDO P/N
Accent	2011>	1.6 L Petrol Man/Auto	RF sws	412.228
Accent	2011>	1.6 L Petrol Man/Auto	Stalk LH	412.229
Accent	2012>	1.6 L Diesel Man/Auto	RF sws	412.230
Accent	2012>	1.6 L DieselMan/Auto	Stalk LH	412.231
H1 imax+iload	2007>	Diesel Man & Auto	Wired sws	412.113
H1 imax+iload	2007>	Diesel Man & Auto	Stalk LH	412.114
H1 imax+iload	2007>	petrol Auto	Stalk LH	412.115
H1 imax+iload	2007>	petrol Man	Wired sws	412.177
H1 iMax + iLoad	2007>	Petrol Auto	Wired sws	412.284
i20 DBW	2012>	1.4 L Petrol Man/Auto	RF sws	412.232
i20 DBW	2012>	1.4 L Diesel Man/Auto	Stalk LH	412.233
i30	2007>	Diesel	OEM	412.110
i30	2007>	Diesel	Stalk LH	412.111
i30	2007>	2.0lt petrol Man	OEM	412.112
i30	2007>	2.0lt petrol Auto	OEM	412.174
i30	2010>	1.6lt petrol Man	OEM	412.175
i30	2010>	1.6lt petrol Auto	OEM	412.176
i40	2012>	Petrol & Diesel	Stalk LH	412.320
i40	2012>	Petrol & Diesel	D-Shaped RF sws	412.321

ISUZU				
Make/Series	Year	Spec	Control Switch	VDO P/N
D-Max	2007>	All	RF sws	412.269
D-Max	June 2012>	All	Stalk LH	412.322
D-Max	June 2012>	All	D-Shaped RF sws	412.323
D-Max Ute	2008>	3.0 L	Stalk LH	412.227
F- Series	>2006	6HK Diesel, DBW	Stalk L/H	412.300
F- Series	2007>	Euro 5 engine Diesel 24v Man	LH Stalk	412.355
N series	2008>	All	Stalk LH	412.116
N-Series	2006/7	All Diesel (Incl. Pwr Reg)	Stalk LH	412.238
SRR 500	2010	Euro 5 engine Die 24v Man	LH Stalk	412.355

JEEP				
Make/Series	Year	Spec	Control Switch	VDO P/N
Patriot	2010>	Petrol	RF sws	412.117
Patriot	2010>	Petrol	Stalk LH	412.178

KIA				
Make/Series	Year	Spec	Control Switch	VDO P/N
Cerato	2009>	2.0 Petrol	Stalk LH	412.249
K2900	2009>	All	Stalk LH	412.118
K2900	2009>	All	RF sws	412.119
Rio	2011>	1.4 DBW	Wired Sws	412.248
Rio	2011>	1.4 DBW	Stalk LH	412.270
Sorento	2005-2009	2.5 Tdi	Stalk LH	412.324
Soul	2009>	Petrol & Diesel	Stalk LH	412.325
Soul	2009>	Petrol & Diesel	D-Shaped RF sws	412.326

CRUISE CONTROL APPLICATION LISTING

LAND ROVER

Make/Series	Year	Spec	Control Switch	VDO P/N
TD4 Defender	2007>	Tdi	R/H stalk	412.120
TD5 Defender	2000-06	Tdi	R/H stalk	412.179

MAHINDRA

Make/Series	Year	Spec	Control Switch	VDO P/N
Pik-up	2010>	2.5TDi/CRDi	Stalk LH	412.180
Pik-up	2010>	2.5TDi/CRDi	RF sws	412.181

MAZDA

Make/Series	Year	Spec	Control Switch	VDO P/N
2	2008>	All	Stalk LH	412.121
2	2008>	All	Wired sws	412.122
3 Series 1	2004>.2006	Man /Auto	Gen. Style sws *	412.222
BT50	2007>	w/airbag	Gen type sws	412.123
Mazda 3	2006-2008	Series 2 All	OEM	412.327
Tribute	2006>	2.3 Auto DBW	Stalk L/H	412.301
Tribute	2006>	2.3 Auto DBW	OEM	412.302

MERCEDES BENZ

Make/Series	Year	Spec	Control Switch	VDO P/N
Sprinter	2007>	Diesel Auto	Stalk L/H	412.288
Sprinter	2001-2006	Diesel	Stalk LH	412.328
Sprinter	2001-2006	Diesel	D-Shaped RF sws	412.329
Sprinter	2006>	All	D-Shaped RF sws	412.330
Vito 115CDi 639	2005>	2.1 Diesel Auto	RF sws	412.250

MINI

Make/Series	Year	Spec	Control Switch	VDO P/N
Mini	2007>	All	Stalk LH	412.331
Mini	2007>	All	D-Shaped RF sws	412.332

MITSUBISHI

Make/Series	Year	Spec	Control Switch	VDO P/N
Colt	2006>	All	Stalk L/H	412.125
Colt	2006>	All	RF sws	412.126
Colt Turbo	2006>	Turbo	Stalk LH	412.334
Delica	1999-2004	2.8TDi DBW	Stalk LH	412.333
Fuso Canter	2006-2011	Diesel	Stalk LH	412.107
Fuso Canter	July 2011>	3L Man /Auto	Stalk LH	412.219
Fuso Canter	July 2011>	3L Man /Auto	RF sws	412.220
Fuso Rosa bus	2012>	Diesel	Stalk LH	412.251
Lancer	2007>	CJ	RF sws	412.296
Mirage	2013>	All	Left stalk	412.266
Mirage	2013>	auto	RF sws	412.267
Triton	2006-10	3.2lt Diesel	Stalk LH	412.127
Triton	2010>	2.5TDi	Stalk LH	412.335

CRUISE CONTROL APPLICATION LISTING

NISSAN				
Make/Series	Year	Spec	Control Switch	VDO P/N
Almera	2012>	1.5 Petrol	Stalk LH	412.252
Almera	2012>	1.5 Petrol	Wired sws	412.253
Elgrand E51	2005>	V6	OEM	412.262
Micra	2008-10	1.4	Wired sws	412.187
Micra	2008-10	1.4	Stalk LH	412.186
Micra	2010>	1.2	Stalk LH	412.188
Micra	2010>	1.5	Stalk LH	412.190
Micra	2010>	1.2	Wired sws	412.189
Micra	2010>	1.5	Wired sws	412.191
Navara D22	2006>	2.5 crdi	Stalk LH	412.128
Navara D22	2006>	2.5 crdi	RF sws	412.183
Navara D22	2006>	3 Litre D30	Stalk LH	412.212
Navara D40	2006>	2.5 crdi	Wired sws	412.129
Patrol cab chassis	2008>	3.0CRDi	OEM	412.130
Patrol GU Wagon	2004-08	3.0 Tdi	OEM	412.185
Skyline V35	2001-2006	3.5 V6	Wired sws	412.254
Skyline V36	2006>	3.7 V6	Wired sws	412.337
Stagea		2.5T & V6	Stalk LH	412.336
Tiida	2009>	ABS	Stalk LH	412.182
V36	2006>	3.7L V6 Auto/Manual Petrol	wired Sw	412.292
X-Trail	2001>	2.0 Petrol DBW	Stalk LH	412.338

PROTON				
Make/Series	Year	Spec	Control Switch	VDO P/N
Persona	2010>	All	Stalk LH	412.131
Preve	2013>	All	Stalk LH	412.340
S16	2010>	All	Stalk LH	412.132
S16	2013>	CVT Auto	Stalk LH	412.339

RENAULT				
Make/Series	Year	Spec	Control Switch	VDO P/N
Fluence	2010>	Petrol	RF sws	412.133
Kangoo	2004-2008	All	D-Shaped RF sws	412.341
Kangoo	2008>	All	D-Shaped RF sws	412.342
Master	2010>	All	D-Shaped RF sws	412.343
Traffic	2010>	Diesel	RF sws	412.255
Traffic	2010>	Diesel	Stalk LH	412.256

SSANGYONG				
Make/Series	Year	Spec	Control Switch	VDO P/N
Actyon	2011>	A200S	Stalk LH	412.257
Actyon	2012>	A200S Tdi	Stalk LH	412.344
Rexton II	2006>	RX270 Tdi	Stalk LH	412.345

CRUISE CONTROL APPLICATION LISTING

SUZUKI

Make/Series	Year	Spec	Control Switch	VDO P/N
Alto	2010>	1.0 Auto	Stalk LH	412.134
Alto	2010>	1.0 Man	Stalk LH	412.192
Grand Vitara	2005>	1.6 & 2.0 & V6	OEM	412.346
Grand Vitara 3door	2008>	2.4 petrol	OEM	412.136
Kizashi	2010>	Manual	Stalk LH	412.259
Swift	2011>	1.4 petrol	Stalk LH	412.137
Swift	2011>	1.4 petrol	RF sws	412.138
Swift sport	2007>	1.6 (DBW)	Gen type sws	412.135
SX4	2007-10	All	OEM	412.193
SX4	2010>	All	OEM	412.258

TATA

Make/Series	Year	Spec	Control Switch	VDO P/N
Xenon	2007>	2.2 Tdi	Stalk LH	412.347

TOYOTA

Make/Series	Year	Spec	Control Switch	VDO P/N
Alphard	2010	2.4 Petrol Auto	OEM	412.358
Alphard TY210	2010	2.4 petrol Auto		412.358
Coaster	2010>	4.0 Diesel	Stalk LH	412.139
Corolla	2008>	Auto only	RF sws	412.140
Corolla	>2007	Drive-by-wire Man/Auto	Stalk LH	412.224
Corolla	>2007	Drive-by-wire Man/Auto	Stalk + RF sws	412.225
Corolla	SEP-2007>	Manual	RF sws	412.260
Corolla	2008>	1.8 Lt Petrol Auto/manual	RF sws	412.273
Hiace / Commuter	2006>	Pet & Diesel	Stalk LH	412.141
Hiace / Commuter	2006>	Pet & Diesel	RF sws	412.142
Hilux	2005>	2.7 Pet 4 Cyl Man	Gen. Style sws	412.143
Hilux	2005>	4.0 V6 Petrol Manual	Gen. Style sws	412.194
Hilux	2005>	Tdi Man	Gen. Style sws	412.195
Hilux	2005>	Tdi Auto	Gen. Style sws	412.196
Hilux	2005>	2.7 Pet 4Cyl Auto	Gen. Style sws	412.197
Hilux	2005>	4.0 Pet V6 Auto	Gen. Style sws	412.198
Hilux	2000 - 2005	SLE 3Lt Diesel	Stalk L/H	412.299
Landcruiser 70 series	2007> VDJ 76,78,79	V8 4.5 Tdi No A/Bag	Stalk LH	412.144
Landcruiser 70 series	2007> VDJ 76,78,79	V8 4.5 Tdi No A/Bag	RF sws	412.145
Landcruiser 70 series	2003-07	6 cyl (DBW)	Stalk LH	412.199
Landcruiser 70 series	2007> VDJ 76,78,79	V8 4.5 Tdi With A/Bag	Stalk LH	412.200
Landcruiser 70 series	2007>VDJ 76,78,79	V8 4.5 Tdi With A/Bag	RH Stalk (RF)	412.201
Landcruiser L-100 series	2000>	4.2 Tdi 6 cyl. DBW	Stalk LH	412.348
Prado	2005>	Petrol 4L Man.+ AirBags	RF sws	412.287
Prado 90 series	1999-2003	3.0Tdi DBW	Stalk LH	412.349
Prado 120 series	2005>	Diesel 4 cyl Man	OE stalk	412.272
Yaris	2006>Sep 2011	All	Stalk LH	412.147
Yaris	2006>Sep 2011	All	RF sws	412.148

CRUISE CONTROL APPLICATION LISTING

TOYOTA (Continued)				
Yaris (Hatch)	SEP-2011>	New Hatch 1.3 & 1.5	RF sws	412.261
Yaris (Note 1)*	2006>Sep 2011	All	Gen. Style sws *	412.146

VOLKSWAGEN				
Make/Series	Year	Spec	Control Switch	VDO P/N
Amarok	2010>	2.0TDi Diesel	Stalk LH	412.202
Amarok	2010>	2.0TDi Diesel	RF sws	412.203
Amarok	2010>	2.0 Petrol	RF sws	412.279
Amarok	2010>	2.0 Petrol	Stalk LH	412.280
Caddy	2010>	All	RF sws	412.150
Caddy	2011<	All	RF sws	412.223
Caddy	2011>	GP Manual	RF sws	412.277
Crafter	2006>	All	RF sws	412.151
Crafter	2006>	All	Stalk LH	412.152
Golf	2010>	Tsi	RF sws	412.153
Golf	2011>	DSG Auto	RF sws	412.236
Polo	2013>	Petrol Manual	RF sws	412.285
Polo	2013>	Petrol DSG	RF sws	412.286
T5 Transporter	>2008	Man	Stalk LH	412.204
T5 Transporter	>2008	Man	RF sws	412.205
Transporter 2009	2009>	Man	RF sws	412.149
Transporter 2009	2009>	DSG	RF sws	412.206
Up	2012>	Manual	Stalk LH	412.244
Up	2012>	Manual	RF sws	412.245

SENDERS, SWITCHES & ADAPTORS

PRESSURE SENDERS & SWITCHES

A

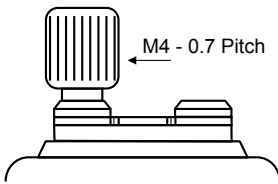

B

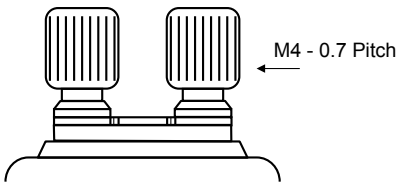

C

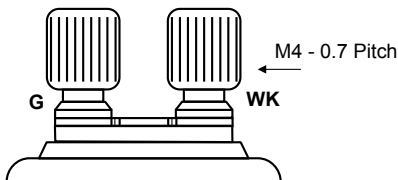

D

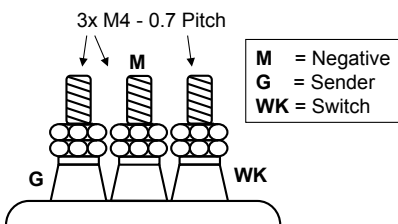

M = Negative
G = Sender
WK = Switch



Pressure Sender - Oil / Air				Single Station	
Part No.	Range Bar (Psi)	Thread Size	Switch Point Bar (Psi)	Picture	Ohms Range
360081032025C	0 - 2 Bar (30)	1/8"-27NPTF	---	B	10 - 180
360081032011C	0 - 2 Bar (30)	M 12x1.5	---	B	10 - 180

Pressure Sender - Oil / Air				Single Station	
Part No.	Range Bar (Psi)	Thread Size	Switch Point Bar (Psi)	Picture	Ohms Range
360081032001C	0 - 5 Bar (75)	1/8"-27NPTF	---	B	10 - 180
360081032002C	0 - 5 Bar (75)	M10x1.0	---	B	10 - 180

Pressure Sender & Switch - Oil / Air				Single Station	
Part No.	Range Bar (Psi)	Thread Size	Switch Point Bar (Psi)	Picture	Ohms Range
360081030001K	0 - 5 Bar (75)	M10x1.0	0.25 Bar (3.5)	C	10 - 180
360081030002K	0 - 5 Bar (75)	M10x1.0	0.5 Bar (7)	C	10 - 180
360081030028K	0 - 5 Bar (75)	M14x1.5	0.5 Bar (7)	C	10 - 180
360081030049K	0 - 5 Bar (75)	1/8"-27NPTF	0.5 Bar (7)	C	10 - 180
360081030014C	0 - 5 Bar (75)	M10x1.0	0.6 bar (8.5)	C	10 - 180
360081030010C	0 - 5 Bar (75)	1/8"-27NPTF	1.4 Bar (11.5)	C	10 - 180
360081039002C	0 - 5 Bar (75)	1/8"-27NPTF	11.5 Psi	D	10 - 180
360081039004C	0 - 5 Bar (75)	1/8"-27NPTF	10 Psi	D	10 - 180

Pressure Sender & Switch - Oil / Air				Single Station	
Part No.	Range Bar (Psi)	Thread Size	Switch Point Bar (Psi)	Picture	Ohms Range
360081030009K	0 - 10 Bar (150)	M10x1.0	0.5 Bar (7)	C	10 - 180
360081030022C	0 - 10 Bar (150)	M12x1.5	0.5 Bar (7)	C	10 - 180
360081030052C	0 - 10 Bar (150)	1/8"-27NPTF	0.5 Bar (7)	C	10 - 180
360081030039C	0 - 10 Bar (150)	M10x1.0	0.75 Bar (10.7)	C	10 - 180
360081030015C	0 - 10 Bar (150)	1/8"-27NPTF	0.8 Bar (11.5)	C	10 - 180
360081030017C	0 - 10 Bar (150)	M10x1.0	0.9 Bar (12)	C	10 - 180
360081039003	0 - 10 Bar (150)	1/8"-27NPTF	0.8 Bar (11.5)	D	10 - 180

Pressure Sender - Oil / Air				Single Station	
Part No.	Range Bar (Psi)	Thread Size	Switch Point Bar (Psi)	Picture	Ohms Range
360081038008C	0 - 30 Bar (400)	1/8"-27NPTF	---	B	10 - 180
360081032014C	0 - 10 Bar (150)	1/8"-27NPTF	---	B	10 - 180
360081038003C	0 - 25 Bar (350)	1/8"-27NPTF	---	B	10 - 180

Pressure Sender - Oil / Air				Dual Station	
Part No.	Range Bar (Psi)	Thread Size	Switch Point Bar (Psi)	Picture	Ohms Range
362081001001K	0 - 5 Bar (75)	1/8"-27NPTF	---	B	5 - 90
362081001002K	0 - 10 Bar (150)	1/8"-27NPTF	---	B	5 - 90
362081003002K	0 - 10 Bar (150)	1/8"-27NPTF	---	A	5 - 90
362081002001K	0 - 25 Bar (350)	1/8"-27NPTF	---	B	5 - 90
362081004001C	0 - 25 Bar (350)	1/8"-27NPTF	---	A	5 - 90

OIL PRESSURE SENDER SPECIFICATIONS

Oil Pressure Sender Specifications						
Part No.	Gauge KPa	Gauge PSI	Ohms	Light Switch KPa	Thread	Body Type
360.001	500 KPa	75psi	10-180 ohms	-	1/8"27NPTF	Blade (F)
360.002	1000 KPa	150psi	10-184 ohms	-	1/8"27NPTF	Blade (F)
360.003	700 KPa	100psi	73-10 ohms	-	1/4"18NPT	Blade (F)
360.004	500 KPa	75 psi	10-180 ohms	-	1/4"18NPT	Blade (F)
360.005	500 KPa	75 psi	73-10 ohms	-	1/4"18NPT	Blade (F)
360.006	600 KPa	87 psi	292-40 ohms	-	1/8"-28BSP	Blade (F)
360.008	800 KPa	116 psi	0-90 ohms	-	1/8"-27NPTF	M4 Post (K)
360.013	700 KPa	100psi	10-180 ohms	-	1/4"18NPT	Button (G)
360.014	600 KPa	87 psi	10-180 ohms	-	1/8"27NPTF	Blade (F)
360.015	700KPa	100 psi	130-34 ohms	-	M14x1.5	3 pin plug
360.016	500 KPa	75 psi	10-180 ohms	-	1/8"28BSP	Button (G)
360.017	600 KPa	87 psi	10-180 ohms	50 KPa	1/8"28BSP	Bullet & Button (J)
360.018	500 KPa	75 psi	10-180 ohms	-	1/8"27NPTF	M4 Post (K)
360.019	1000 KPa	150 psi	10-184 ohms	-	1/8"27NPTF	M4 Post (K)
360.020	600 KPa	87 psi	10-180 ohms	-	1/8"27NPTF	M4 Post (K)
360.021	300 KPa	42 psi	0-90 ohms	-	M12 x 1.5	Bullet (H)
360.022	500 KPa	75 psi	10-183 ohms	30 KPa	M10 x 1.0	2 Spades (B)
360.024	875 KPa	125 psi	0-5 volt (ecu)	-	M14x1.5	3 pin plug
360.025	800 KPa	116 psi	Bi-metal (56ohms)	-	M16 x 1.5	Button (G)
360.026	800 KPa	116 psi	Bi-metal (56ohms)	-	1/8"28BSP	1 pin plug
360.027	600 KPa	87 psi	10-180 ohms	-	1/8x28BSP	Button (G)
360.028	800 KPa	116 psi	Bi-metal (56ohms)	-	1/8x28BSP	Button & Earth Spade
360.029	800 KPa	116 psi	Bi-metal (56ohms)	60 KPa	1/8x28BSP	2 Pin Plug
360.045	700KPa	100 psi	10-73 ohms	-	1/4"18NPT	Blade (L)
360.048	10 bar	150 psi	0-5 Volts	-	M12x1.5	4 pin ISO 15170
360.050	5 bar	80 psi	240-33 ohms	-	1/8"-27NPT	M4
360.086	700KPa	100 psi	10-180 ohms	-	1/8"27NPTF	M4 Post (K)

Note: KPa/psi = Switch Point

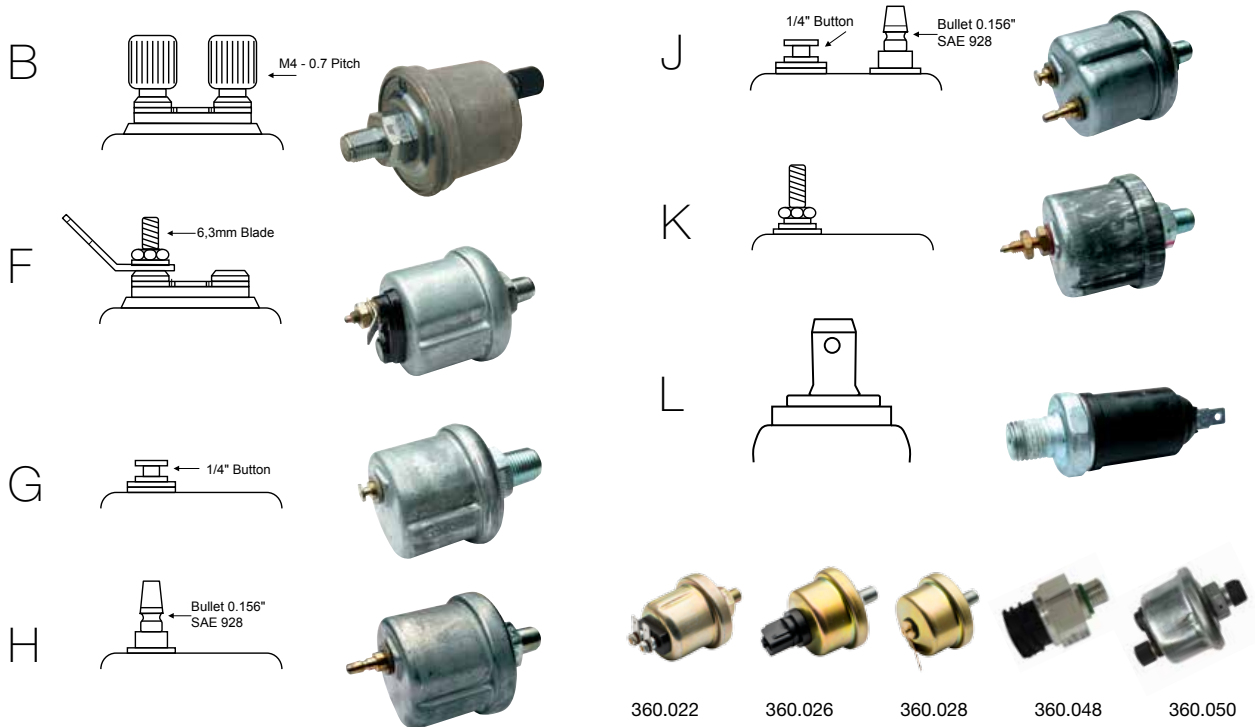

PRESSURE SWITCHES



Pressure Switches - Light Duty

Part No.	Thread Size	Terminal	Switch Kpa	Switch	Voltage
231.081	1/4"-18NPTF	Button	25 kpa	NC	12/24v
231.082	1/8"-27NPTF	Spade	21 kpa	NC	12/24v
231.083	1/8"-27NPTF	Button	55 kpa	NC	12/24v
231.084	1/8"-28BSPT	Button	21 kpa	NC	12/24v
231.085	M10x1.0	Spade	25 kpa	NC	12/24v
231.086	1/8"-28BSPT	Bullet	21 kpa	NC	12/24v
231.087	M14x1.5	Spade	21 kpa	NC	12/24v
231.088	1/4"-18NPTF	Plug (3 pin)	21 kpa	ECU	12/24v
231.089	1/8"-28BSPT	Plug (1 pin)	21 kpa	NC	12/24v
231.091	M10x1.0	Spade	50 kpa	NC	12/24v
231.092	1/2"-20UNF	Spade	55 kpa	NC	12/24v
231.094	M12x1.5	Post/Nut	40 kpa	NC	12/24v
231.096	M14x1.5	3 Spades	30 kpa	NC	12/24v
231.100	1/4"-18NPT	Plug (1 pin)	40 kpa	NC	12/24v
231.101	1/8"-28BSPT	Bullet	30 kpa	NC	12/24v
231.102	1/8"-28BSPT	Spade	50 kpa	NC	12/24v
231.104	M8 x 1.0	Plug (1 pin)	40 kpa	NC	12/24v
231.106	1/4"-18NPTF	Spade	40 kpa	NC	12/24v
231.109	M12x1.5	Spade	35 kpa	NC	12/24v
231.111	M10x1.0	Spade	40 kpa	NO	12/24v
231.112	1/8"-27NPTF	Spade	50 kpa	NC	12/24v
231.113	M14x1.5	Plug (1 pin)	50 kpa	NC	12/24v
231.114	M14x1.5	Plug (1 pin)	50 kpa	NC	12/24v
231.116	1/8"-28BSPT	Plug (2 pin)	20 kpa	NC	12/24v
231.121	M14x1.5	Plug (1 pin)	50 kpa	NC	12/24v
231.122	M16 x 1.5	Plug (3 pin)	ECU	ECU	12/24v
231.125	M12 x 1.5	Plug (3 pin)	30 kpa	NC	12/24v
231.129	1/8"-28BSPT	Philips Head	40 kpa	NC	12/24v
231.130	M10x1.0	Spade	30 kpa	NC	12/24v
231.137	1/4"-18NPTF	Thread Post	30 kpa	NC	12/24v
231.140	M10x1.0	Spade	50 kpa	NC	12/24v
231.147	1/4"-18NPTF	Plug (1 pin)	25 kpa	NC	12/24v
231.148	M14x1.5	Plug (1 pin)	50 kpa	NC	12/24v
231.150	M14 x 1.5	Plug (3 pin)	ECU	ECU	12/24v
231.177	M14x1.5	Plug (1pin)	30 kpa	NC	12/24v

Pressure Switches - Heavy Duty

Part No.	Switch Point Bar (Psi)	Thread Size	Terminals Contact	Picture	Switch
230.044	0.5 Bar (7) Fixed	1/8"-27NPTF	Screw x 2	N	N/C
		Insulated Return			
230.041	0.7 Bar (10) Fixed	1/8"-27NPTF	Screw x 1	M	N/C
		Earth Return			
230.043	0.7 Bar (10) Fixed	1/8"-27NPTF	Screw x 1	M	N/O
		Earth Return			
230.050	0.5 Bar (7) Fixed	1/8"-27NPTF	Screw x 2	N	N/O
		Insulated Return			
230.990	7 - 25 Psi Adjustable	1/8"-27NPTF	Screw x 2	O	N/C
		Insulated Return			
230.993	15 - 150 Psi Adjustable	1/8"-27NPTF	Screw x 2	O	N/C
		Insulated Return			

PRESSURE SWITCHES for a range of applications

The VDO Pressure Switches are robust, compact and designed to operate in harsh environments at various pressures and in extended duty applications.

Because of its special internal design, this switch can tolerate high pressure spikes inherent in many pressure systems. The switch is factory calibrated but in the case that adjustment is needed in the field, the switch offers an adjustment screw to facilitate any fine tuning required within the given set point range. The standard polyimide diaphragm (Kapton), makes it compatible with many gases, oils, jet fuels and similar hydrocarbons media. Standard screw type electrical terminals are available. Also included with the switch are screw to blade converters.

The overall ruggedness of the VDO Pressure Switch makes it a popular choice for many OEM and aftermarket applications.

Pressure Switches - Fuel / Oil / Air					
Part No.	Description Pressure Switch Brass	Preset	Range	Thread Type	
330.102	Press Sw 2 Term N/O 1.1 - 3psi	2psi	1.1 - 3psi N/O	1/8"-27NPFT	
330.102C	Press Sw 2 Term N/C 1.1 - 3psi	2psi	1.1 - 3psi N/C	1/8"-27NPFT	
330.104	Press Sw 2 Term N/O 3.1 - 7psi	4psi	3.1 - 7psi N/O	1/8"-27NPFT	
330.104C	Press Sw 2 Term N/C 3.1 - 7psi	4psi	3.1 - 7psi N/C	1/8"-27NPFT	
330.110	Press Sw 2 Term N/O 8 - 13psi	10psi	8 - 13psi N/O	1/8"-27NPFT	
330.110C	Press Sw 2 Term N/C 8 - 13psi	10psi	8 - 13psi N/C	1/8"-27NPFT	
330.115	Press Sw 2 Term N/O 14 - 24psi	15psi	14 - 24psi N/O	1/8"-27NPFT	
330.115C	Press Sw 2 Term N/C 14 - 24psi	15psi	14 - 24psi N/C	1/8"-27NPFT	
330.135	Press Sw 2 Term N/O 25 - 50psi	35psi	25 - 50psi N/O	1/8"-27NPFT	
330.135C	Press Sw 2 Term N/C 25 - 50psi	35psi	25 - 50psi N/C	1/8"-27NPFT	
330.160	Press Sw 2 Term N/O 51 - 90psi	60psi	51 - 90psi N/O	1/8"-27NPFT	
330.160C	Press Sw 2 Term N/C 51 - 90psi	60psi	51 - 90psi N/C	1/8"-27NPFT	
330.1100	Press Sw 2 Term N/O 91 - 150psi	100psi	91 - 150psi N/O	1/8"-27NPFT	
330.1100C	Press Sw 2 Term N/C 91 - 150psi	100psi	91 - 150psi N/C	1/8"-27NPFT	
Dead Band:	8 - 13psi = 3.5 psi	25 - 50psi = 15psi	91 - 150psi = 40psi		
Tolerance:	0.5 - 1 Psi +/- 0.3psi	1.1 - 3psi +/- 0.5psi	3.1 - 7psi +/- 0.1psi		
	8 - 13psi +/- 0.2psi	14 - 24psi +/- 0.2psi	25 - 50psi +/- 0.5psi		
	25 - 50psi +/- 0.1psi				
Working pressure:	150psi for 0.5 - 24psi, 250psi for 25 - 150psi.				
Burst pressure:	750psi for 0.5 - 24V, 1250psi for 25 - 150psi.				



2 Terminals

Pressure Switches - universal - Fuel / Oil / Air - Dual circuit				
Part No.	Description Pressure Switch Brass	Preset	Range	Thread Type
430.102	Press Sw 3 Term NC/NO 1.1 - 3psi	2psi	1.1 - 3psi	1/8"-27NPFT
430.104	Press Sw 3 Term NC/NO 3.1 - 7psi	4psi	3.1 - 7psi	1/8"-27NPFT
430.110	Press Sw 3 Term NC/NO 8 - 13psi	10psi	8 - 13psi	1/8"-27NPFT
430.115	Press Sw 3 Term NC/NO 14-24 psi	15psi	14 - 24psi	1/8"-27NPFT
430.135	Press Sw 3 Term NC/NO 25-50 psi	35psi	25 - 50psi	1/8"-27NPFT
430.160	Press Sw 3 Term NC/NO 51-90 psi	60psi	51 - 90psi	1/8"-27NPFT
430.1100	Press Sw 3 Term NC/NO 91-150 psi	100psi	91 - 150psi	1/8"-27NPFT



3 Terminals

Cover	
Part No.	Description
330.100	Cover

TEMPERATURE SWITCHES

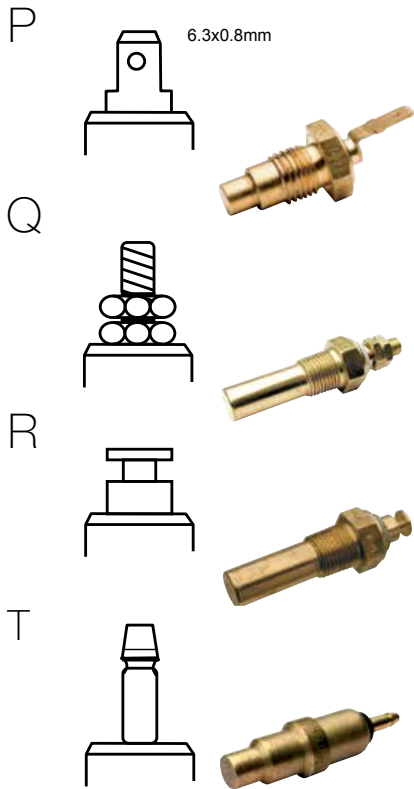

Temp Switch - Normally Open Contact - Single Terminal 3 Watt

Part No.	Switch Point	Thread Size	Term	Body Length	Max Temp	Diam.
232011017087D	40±3°C	M14x1.5	T	29 mm	120	10
232011017038D	55±3°C	M14x1.5	P	29 mm	120	10
232011017017D	85±3°C	M14x1.5	P	29 mm	120	10
230.046	90±3°C	M10x1.5	Q	38.5 mm	120	6.9
232011017016D	95±3°C	M14x1.5	P	29 mm	150	10
230.051	95±3°C	1/2-14 NPTF	P	29 mm	120	10
230.045	96±3°C	1/8-27 NPTF	Q	33 mm	120	10
232011017080D	97±3°C	M14x1.5	P	29 mm	120	10
232011017034D	100±3°C	M14x1.5	P	29 mm	160	10
232.011/017/041	105±3°C	1/2-14 NPTF	P	29 mm	120	10
232011017010D	110±3°C	M14x1.5	P	29 mm	160	10
232011017032D	120±3°C	M14x1.5	P	29 mm	130	10
232011017103D	130±3°C	M14x1.5	P	29 mm	150	10
232011005027D	150±5°C	M10x1.5	R	38.5 mm	200	6.9
232011005017D	150±5°C	M10x1.5	Q	38.5 mm	200	6.9
232011005004D*	170±5°C	M10x1.5	Q	38.5 mm	220	6.9

Note: All VDO Switches are N/O (normally open)

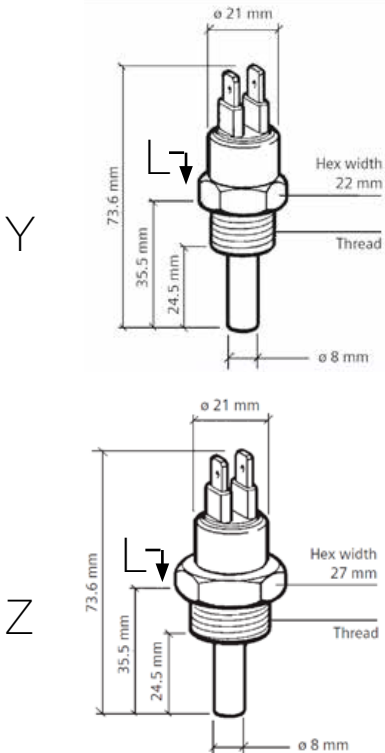

Temp Switch - N/O Contact (except * N/C) Dual Terminal 100 Watt

Part No.	Switch Point	Thread Size	Term	Body Length L	Max Temp	Diam.
X10232001001	64±3°C	M14x1.5	Y	35.5 mm	110	8
X10232001002	82±3°C	M18x1.5	Y	35.5 mm	110	8
X10232001003	86±3°C	M18x1.5	Y	35.5 mm	110	8
X10232001004	92±3°C	M18x1.5	Y	35.5 mm	110	8
X10232001005	96±3°C	M18x1.5	Y	35.5 mm	110	8
X10232001006	96±3°C	1/2-14 NPTF	Y	43.5 mm	110	8
X10232001007	96±3°C	M14x1.5	Y	35.5 mm	110	8
X10232001008	96±3°C	M22x1.5	Z	35.5 mm	110	8
X10232001009	100±3°C	M18x1.5	Y	35.5 mm	110	8
X10232001010	105±3°C	M18x1.5	Y	35.5 mm	160	8
230.093	105±3°C	1/8-27NPTF	Y	33 mm	120	6.9
230.110NC*	50±3°C	1/8-27NPTF	Y	30.0 mm	110	8
230.111NO	50±3°C	1/8-27NPTF	Y	30.0 mm	110	8
230.112NO	70±3°C	1/8-27NPTF	Y	30.0 mm	110	8
230.113NC*	75±3°C	1/8-27NPTF	Y	30.0 mm	110	8
230.114NC*	95±3°C	1/8-27NPTF	Y	30.0 mm	110	8
230.115NO	95±3°C	1/8-27NPTF	Y	30.0 mm	110	8
230.115NC*	105±3°C	1/8-27NPTF	Y	30.0 mm	120	8

Note: Temp Switches 230.110 to 230.115 includes a rubber boot.

Temp Control Switch 100 Watt

Part No.	Switch Point	Thread Size	Term	Body Length L	Max Temp	Diam.
230.079	95±3°C	1/2-14 BSP	Y	13 mm	120	12
230.080	102±3°C	1/2-14 BSP	Y	13 mm	120	12

Note: VDO Switches are N/O (normally open) with the exception of p/n 230.xxx marked "NC"

230.079

TEMPERATURE SENDERS & SWITCHES

Temp Sender				40 - 120 Deg. C	
Part No.	Thread Size	Term	Body Length	Ohms Range 40-120 °C	
323801001006K	M14x1.5	P	29mm	287-23 ohms	
323801001040N	M16x1.5	P	29mm	287-23 ohms	
323801001010K	1/2-14 NPTF	P	29mm	287-23 ohms	
323801001009N	1/4-18 NPTF	P	29mm	287-23 ohms	
323801001008N	5/8-18 UNF-3A	P	29mm	287-23 ohms	
323805001001K	M14x1.5	U	29mm	287-23 ohms	
323805001015N	M18x1.5	U	29mm	287-23 ohms	
323805001004K	1/2-14 NPTF	U	29mm	287-23 ohms	
323805001005N	3/8-18 NPTF	U	29mm	287-23 ohms	
323805001002C	5/8-18 UNF-3A	U	29mm	287-23 ohms	

Temp Sender				50 - 150 Deg. C	
Part No.	Thread Size	Term	Body Length	Ohms Range 50-150 °C	
323801010001D	M10x1.5	R	29mm	323-18 ohms	
323805003001N	M14x1.5	U	29mm	323-18 ohms	
323805003002N	1/4-18 NPTF	U	29mm	323-18 ohms	

Note: Not all the above temperature senders are suitable for the cockpit gauges. Some temp senders are used in OEM applications.

Temp Sender & Switch N/O						40 - 120 Deg. C	
Part No.	Switch Point	Thread Size	Term	Body Length	Ohms Range 40-120 °C		
323803001004D	90±3°C	M14x1.5	V	40mm	287-23 ohms		
323803001006D	96±3°C	M14x1.5	V	40mm	287-23 ohms		
323803001008D	110±3°C	M14x1.5	V	40mm	287-23 ohms		
323803001011D	95±3°C	5/8-18 NF-3	V	40mm	287-23 ohms		
323803001002D	98±3°C	5/8-18 NF-3	V	40mm	287-23 ohms		
323803001012D	100±3°C	5/8-18 NF-3	V	40mm	287-23 ohms		
323803001019D	95±3°C	1/2-14 NPTF	V	40mm	287-23 ohms		
323803001013D	106±3°C	M14x1.5	V	40mm	287-23 ohms		
323803004002D	105±3°C	M14x1.5	X	40mm	287-23 ohms		

Note: All temp switches are N/O (normally open) rated **3 Watts**

Temp Sender Dual Station (2 Gauges)					40 - 120 Deg. C	
Part No.	Thread Size	Term	Body Length	Ohms Range 40-120 °C		
325805003001C	1/4-18NPTF	U	40mm	144-12 ohms		

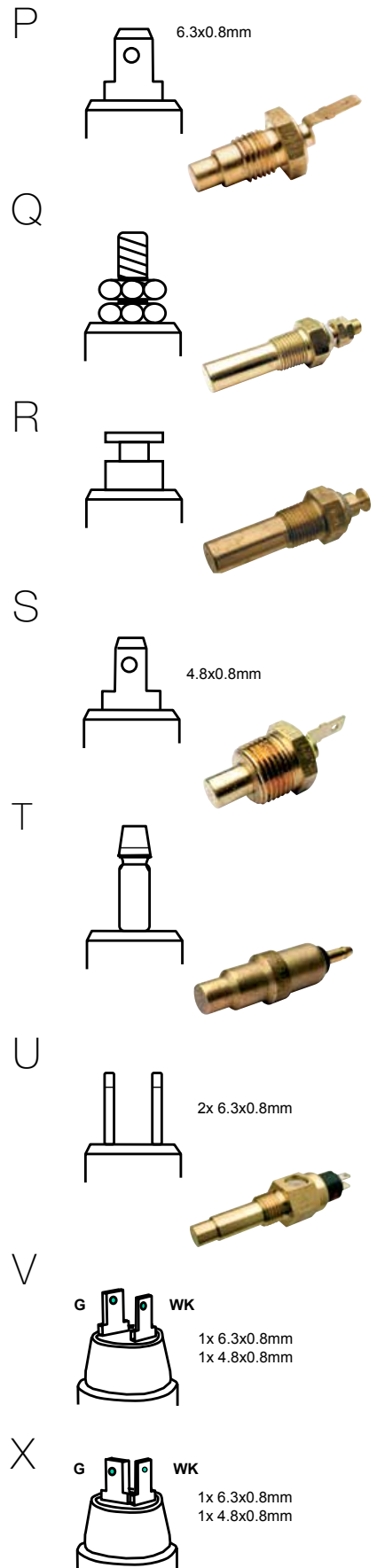

Note: Images shown are an example of terminals shape only.

TEMPERATURE SENDER SPECIFICATION



Sender 320.002



Sender 320.093



Sender 320.028



Sender 320.039



Sender 320.107

Temp Sender							
Part No.	Range	Ohms (Ω)	Ω@ 100°C	Thread	Body Length	Insulator	Terminal
320.002	40-120°C	287-23	38.6	1/8"-27 NPTF	29.0mm	white	button
320.003	40-120°C	73-10	17.5	1/8"-27 NPTF	29.0mm	blue	button
320.004	40-120°C	287-23	38.6	M16x1.5	29.0mm	white	button
320.006	60-200°C	550-14	148.8	1/8"- 27 NPTF	29.0mm	red	button
320.007	50-150°C	323-18	62.2	M14x1.5	29.0mm	white	spade
320.010	50-150°C	323-18	62.2	M12x1.5	10.5mm	-	button
320.011	40-120°C	323-18	62.2	1/8"-27 NPTF	22.0mm	yellow	thread
320.020	60-200°C	550-14	148.8	1/8"-27 NPTF	10.5mm	black	button
320.021	50-150°C	323-18	62.2	1/8"-27 NPTF	29.0mm	yellow	button
320.022	40-120°C	287-23	38.6	1/2"-14 NPTF	29.0mm	white	spade
320.024	40-120°C	282-40	77.4	M12x1 .25	23.0mm	black	spade
320.028	50-150°C	323-18	62.2	1/8"-27 NPTF	10.5mm	yellow	button
320.032	40-120°C	282-40	77.4	1/8"-27 NPTF	29.0mm	black	button
320.033	40-120°C	282-40	77.4	1/8"-27 NPTF	29.0mm	white	button
320.036	40-120°C	282-40	38.6	M16x1.5	29.0mm	black	button
320.039	40-120°C	145-17	31.5	use old nut	17.0mm	black	bullet
320.041	40-120°C	495-38	78.8	M16x1.5	22.0mm	black	bullet
320.042	40-120°C	395-40	83.2	M8x0.75	22.0mm	black	bullet
320.043	40-120°C	184-17	32.0	M16x1.5	22.0mm	black	spade
320.044	40-120°C	313-22	41.2	M16x1.5	27.0mm	black	spade
320.046	40-120°C	380-30	54.0	5/8"-18 UNF	29.0mm	red	spade
320.047	40-120°C	353-24	51.9	M16x1.5	24.0mm	black	bullet
320.060	40-120°C	341-24	45.0	1/8"-27 NPTF	20.0mm	black	bullet
320.062	40-120°C	208-18	31.5	M16x1.5	27.0mm	black	spade
320.065	40-120°C	282-40	75.0	1/8"-27 NPTF	22.0mm	yellow	spade
320.067	40-120°C	232-22	65.9	M8x0.75	22.0mm	black	bullet
320.068	40-120°C	175-20	32.4	M16x1.5	22.0mm	black	bullet
320.081	40-120°C	535-88	151.0	M16x1.5	22.0mm	black	spade
320.082	40-120°C	535-88	151.0	M14x1.5	22.0mm	black	spade
320.083	40-120°C	245-46	77.0	M10x1.0	10.5mm	yellow	button
320.084	40-120°C	245-46	77.0	1/8"-27 NPTF	22.0mm	black	spade
320.085	40-120°C	115-20	35.0	M16x1.5	27.0mm	black	button
320.086	40-120°C	535-88	151.0	M10x1.0	10.5mm	yellow	button
320.087	40-120°C	180-30	45.0	1/8"-28 BSPT	22.0mm	black	spade
320.088	40-120°C	192-30	52.0	1/8"-28 BSPT	22.0mm	black	spade
320.089	40-120°C	535-88	151.0	M14x1.5	22.0mm	black	spade
320.092	50-150°C	323-18	62.2	1/8"-27NPTF	29.0mm	green	thread
320.093	40-120°C	287-23	38.6	1/8"-27NPTF	29.0mm	black	thread
320.107	250°F	450-30		1/8"-27NPT			spade

Note: Not all the above temperature senders are suitable for the cockpit gauges.
Some temp senders are used in OEM applications.

ADAPTORS, brass

Suitable for pressure & temperature senders & switches with 1/8"-27NPTF thread. Mechanical temperature gauges with 1/8"-27NPTF thermowell (180.059). Oil line kits (230.012 & 230.013) for mechanical pressure gauges.

Adaptors Brass			
Part No.	Internal Thread	External Thread	Overall Length
320.050	1/8"-27NPTF	1/4"-18NPTF	20mm
320.051	1/8"-27NPTF	3/8"-18NPTF	20mm
320.052	1/8"-27NPTF	5/8"-18UNF	20mm
320.053	1/8"-27NPTF	1/2"-14NPTF	20mm
320.054	1/8"-27NPTF	M14x1.5	20mm
320.055	1/8"-27NPTF	M16x1.5	20mm
320.056	1/8"-27NPTF	M18x1.5	20mm

Adaptors Brass			
Part No.	Internal Thread	External Thread	Overall Length
320.058	5/8"-18UNF	1/2"-14NPTF	20mm
320.064	1/4"-18UNF	5/8"-18UNF	17mm
320.101	1/4"-14NPTF	1/2"-14NPTF	20mm

Adaptors Brass			
Part No.	Internal Thread	External Thread	Overall Length
180.059	Thermowell	1/8"-27NPTF	20mm

Adaptors Brass	
Part No.	Thread
320.105	M12x1.5 to 1/8" NPT

Adaptors Stainless Steel			
Part No.	Internal Thread	External Thread	Overall Length
320.074	1/8"-27NPTF	1/8"BSPT	
320.075	1/4"-18NPTF	3/8"BSPT	
320.076	1/8"-27NPT	M12x1.25	

T-PIECE ADAPTORS, brass

Suits oil line kits and oil pressure sender units with 1/8"-27 NPTF male thread, while at the same time retaining the existing oil warning light switch.

Adaptors Brass				
Part No.	Thread A	Thread B	Thread C	Length
230.031	1/8"-27NPTF	1/8"-27NPTF	1/8"-27NPTF	66mm
230.032	1/4"-18NPTF	1/4"-18NPTF	1/8"-27NPTF	66mm
230.033	M10x1.0	M10x1.0	1/8"-27NPTF	66mm
230.035	M14x1.5	M14x1.5	1/8"-27NPTF	66mm
230.036	1/8"-28BSPT	1/8"-28BSPT	1/8"-27NPTF	66mm



Thermowell 180.059

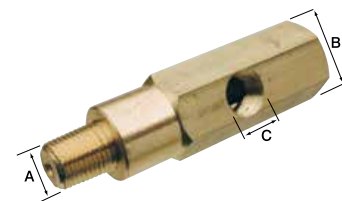



Adjustable float arm sender 220.003



Arm Type Fuel Sender

Does not include Neoprene gasket p/n 36373

Neoprene Rubber Gasket 36373/9A



Welding Flange 22502641141



Flange Mounting Kit N05801432
Suits 220.003 / 220.004 / 220.005
and Tubular T / U Senders



Stainless Steel

Includes NBR Gasket
electrical plug and mating plug

FUEL LEVEL SENDERS

Sender - Float Arm

Part No.	Range	Depth	Voltage
220.003	3-180 ohm	150 - 535mm adjustable	6 - 24V
220.004	0-90 ohm	150 - 535mm adjustable	6 - 24V
220.005	240-33 ohm	150 - 535mm adjustable	6 - 24V

Float Arm Tank Unit - insulated return

Part No.	Range	Depth	Voltage
226801015001C	3-180 ohm	150 - 600mm	6 - 24V

Arm Type Fuel Senders

Tank depth range 145 - 400mm

Part No.	Range	Voltage
A2C59510165	Sender with low fuel warning switch	2.5 -180 ohms
A2C59510171	Arm Type Fuel Sender	2.5 -180 ohms

TANK UNIT SENDER ACCESSORIES

Accessories

Part No.	Description	PCD
36373	Gasket-neoprene rubber	54mm
2251016	Gasket	80mm
22502641141	Welding flange	54mm
115910011401	Welding flange	80mm
N05801432	Flange mounting kit	54mm
2250234	Gasket-cork (dim. as per 36373/9A)	54mm
CTA0200KIT	5-6 hole flange kit	

REED SWITCH SENDERS

Reed switch senders are better choice than float arm sender.

They can operate in tanks for petrol or diesel, without baffles or walls.

They have a long life in comparison to the variable resistors which are directly exposed to the fuel.

Reed switch senders can also be used in tanks containing water to measure their level. Suits 3-180 + 10-180 ohms.

Reed Switch Senders

PCD 54 mm

Part No.	Range E - F	Length	Low Fuel
220.150-180	3-180 Ohms	150 mm	
220.180-180	3-180 Ohms	180 mm	
220.230-180	3-180 Ohms	230 mm	Yes
220.250-180	3-180 Ohms	250 mm	Yes
220.260-180	3-180 Ohms	260 mm	Yes
220.270-180	3-180 Ohms	270 mm	Yes
220.300-180	3-180 Ohms	300 mm	Yes
220.320-180	3-180 Ohms	320 mm	Yes
220.330-180	3-180 Ohms	330 mm	Yes
220.350-180	3-180 Ohms	350 mm	Yes
220.600-180	3-180 Ohms	600 mm	Yes
220.660-180	3-180 Ohms	660 mm	Yes
220.900- 180	3-180 Ohms	900 mm	Yes

Note: Low fuel warning wire to run light/relay.

TUBULAR TYPE SENDERS

Tubular Senders - Fuel (Steel)		PCD 54 mm - Cut-out Dia 41mm	
Part No.	Sender Length	Resistance at Full	Resistance at Empty
224011000015G	150mm	4.5	69
224011000018G	180mm	3	64
224011000020G	200mm	3	68
224011000022G	220mm	3	80
224011000024G	240mm	3	65.5
224011000026G	260mm	2.5	72
224011000028G	280mm	2.5	75.5
224011000030G	300mm	2.5	82.8
224011000034G	340mm	2.5	74
224011000038G	380mm	2.5	73
224011000040G	400mm	2.5	74.9
224011000045G	450mm	2.5	84.3
224011000050G	500mm	2.5	75.4
224011000055G	550mm	2.5	77.6
224011000060G	600mm	2.5	85.3
224011000065G	650mm	2.5	82.2
224011000070G	700mm	2	81.6
224011000075G	750mm	2	82
224011000080G	800mm	2	68.5

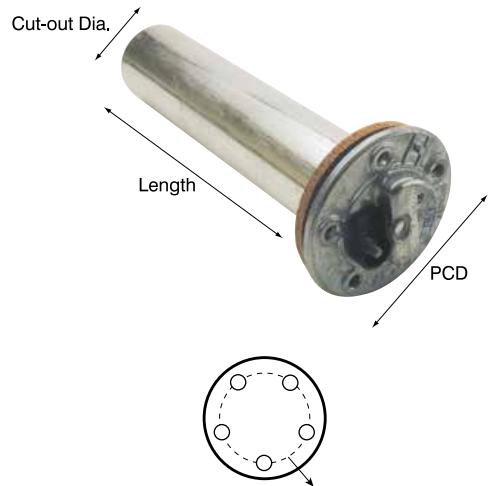

Note: PCD = Pitch Circle Diameter 54mm

Adaptor Plate	
Part No.	Description
CTA0202KIT	Adaptor plate 80mm – 54mm

Note: For a replacement of a 80mm tubular fuel sender, use a 54mm tubular sender above and adaptor plate.

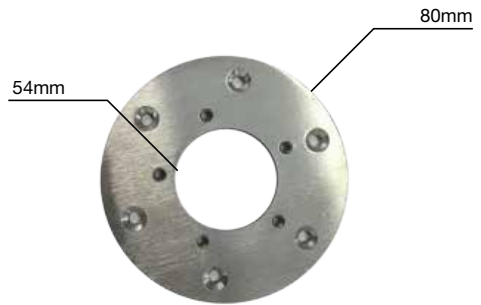

CTA0202 Adaptor plate to fit a 54mm fuel sender to an 80mm application

RPM SENDERS

Inductive Type - 2-wire set-up						
Part No.	Thread Size	L1 mm	L2 mm	L3 mm	L4 mm	Picture
340.007	M18x1.5		25			F
340.008	3/4-16 UNF-2A		44			G
340.009	M18x1.5		84			G
340804007019	M18x1.5	18.2	70.7	71.8 ± 0.1	79.7	G

Note: Use twisted pair or shielded cable between inductive sensor and device requiring signal to eliminate possible electrical interference.

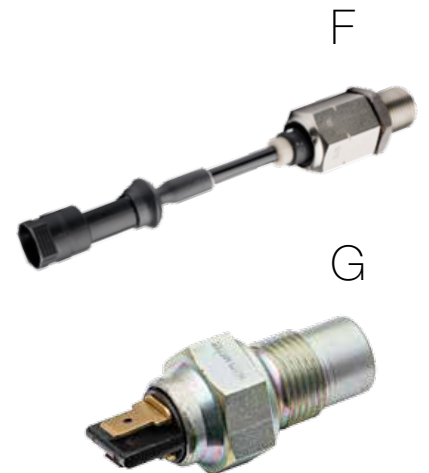

HALL EFFECT SENDERS



Speed sensor 340.011

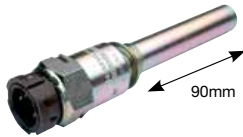

Proximity Sender K70452 (Speed & RPM)

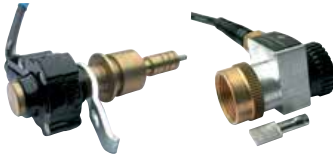

Speed Sensors 340.013 and 340.808



Speed sensor 412.009



GPS Speed sensor 412.010

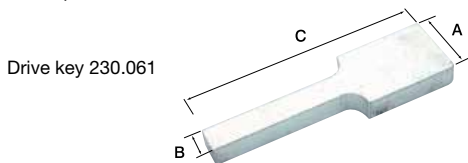

Drive key 230.061

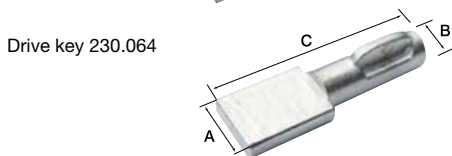

Drive key 230.064

Proximity Switch & Hall Effect - Square wave output - 3-wire Bayonet closed style

Part No.	Voltage	Thread	Pic	Type	Imp/Rev	Plug Kit
K46004	12V	7/8"-18UNF	1	H/E	8	K72221
K46020	12/24V	M22x1.5 L/H male	1	H/E	8	K72221
K46021	12/24V	7/8"-18UNF	1	H/E	8	K72221
K70450	12V	M22x1.5 L/H female	2	H/E	8	K72222
K70451	12V	7/8"-18UNF female	2	H/E	8	K72222
340808001004G		7/8" - 18	3	Gen	4	
215992021F	Cable 15m - suits Hall Effect Sender 3 Pin.					
340.011	Hall effect suits G.M. U.S.A.	2.7mm square			16	7/8"-18UNF

Note: Part numbers supplied without Plug Kit
Nuts to suit are optional #230.070 7/8"-18UNF - M22x1.5LH
#230.071 M22x1.5LH - 3/4-26UNF

SPEEDOMETER SENDERS

Proximity Senders (Hall Effect) - 4 Blade Bayonet Type

Part No.	Imp/Rpm	Connection	Length	Voltage
K70452	2 x 8 (180 out of Phase)	M18x1.5	90mm	12V
K70453	2 x 8 (180 out of Phase)	M18x1.5 (Volvo Type)	25mm	12V
340216001024	2 x 8 (180 out of Phase)	M18x1.5 (Volvo Type)	63mm	12V
215950003101	2 x 8 (180 out of Phase)	M18x1.5	20mm	12V
215950004301	2 x 8 (180 out of Phase)	M18x1.5	25mm	12V
215950004501	2 x 8 (180 out of Phase)	M18x1.5	35mm	12V
215920102301	2 x 8 (180 out of Phase)	M18x1.5	25mm	12V

Speedometer Senders

Part No.	Description	Drive Key	Pulses/Rev	Nut Size
340.808	In line suits various vehicles with M22 nut size	3x8mm blade	8	M22 x 1.5mm Inc. 5mm dia lug drive key
340.013	Snap fit suits Ford U.S.A. (C4 transmission)		16	Snap fit
412.009	Universal cut cable	2.7mm square	6	
412.010	GPS Speedo Sender		8	12V/24V

DRIVE KEYS

Suitable for tacho and speedo generators, Hall-effect senders etc.

Drive Keys

Part No.	Dimension A	Dimension B Diam.	Dimension C
K72103	2.6 x 8mm	2.6mm	26mm
230.061	3.0 x 8mm	3.0mm	28mm
230.062	2.6 x 8mm	3.8mm	26mm
230.063	2.6 x 8mm	4.7mm	26mm
230.064	2.6 x 8mm	5.0mm	26mm
230.065	2.6 x 8mm	5.1mm	30mm
K72113	2.6 x 8mm	5.2mm	26mm

VEHICLE SENDERS APPLICATION LISTING

ALFA ROMEO					Light	Gauge	Gauge
Make/Series	Model	Year	Engine	Capacity	Oil Switch	Temp Sender	Pressure Sender
75	Twin-Spark	88-92	4 Cyl 06224	2.0L	231.085		
75	AR162	86-92	6 Cyl 01911, 06174	2.5L, 3.0L	231.085		
147		00-On	4 Cyl, 6 Cyl	All	231.177		
156		99-04	4 Cyl, 6 Cyl	2.0L, 2.5L	231.177		
166		99-01	6 Cyl	3.0L	231.177		
GT	2D Coupe	04-on	4 Cyl, 6 Cyl	2.0L, 3.0L	231.177		
GTV	All	98-on	4 Cyl, 6 Cyl	2.0L, 3.0L	231.177		
Spider	JTS Lusso, Convert	03-05	4 Cyl, 6 Cyl	2.0L	231.177		

AUDI					Light	Gauge	Gauge
Make/Series	Model	Year	Engine	Capacity	Oil Switch	Temp Sender	Pressure Sender
80	CC, 1.8E Quattro, 2.0 & 2.0S	86-87	4 Cyl	1.8L	231.130	320.086	360.022
80	CC, 1.8E Quattro	86-87	4 Cyl	1.8L	231.111	320.086	360.022
90	Sport & Quattro	89-92	5 Cyl	2.3L	231.130		
100	CD	83-91	5 Cyl	2.1L	231.130		
100	CD	83-91	5 Cyl	2.1L	231.111		
200	Turbo	86-91	5 Cyl	2.2L	231.130		
A3	4D Hatchback	97-04	4 Cyl	1.6L	231.111		
A3	4D Hatchback, Turbo	97-04	4 Cyl	1.8L	231.111		
A4	4D Hatchback, Turbo	95-01	4 Cyl	1.8L	231.111	320.086	360.022
A4	1.8T (incl. Quattro)	95-99	4 Cyl	1.8L	231.111		
A4	2.4 V6	98-01	6 Cyl	2.4L	231.130		
A4	2.4 V6	98-on	6 Cyl	2.4L	231.111		
A4	2.4 V6	95-99	6 Cyl	2.6L	231.130		
A4	2.6 V6	95-99	6 Cyl	2.6L	231.130		
A4	2.6 V6 Quattro	95-99	6 Cyl	2.4L	231.111		
A4	2.6 V6 Quattro	94-97	6 Cyl	2.6L	231.111		
A6	2.8 Quattro	94-99	6 Cyl	2.8L	231.130		
A8	3.7 V8	96-99	6 Cyl	3.7L	231.130		
A8	4.2 V8	96-99	6 Cyl	4.2L	231.130		

BMW					Light	Gauge	Gauge
Make/Series	Model	Year	Engine	Capacity	Oil Switch	Temp Sender	Pressure Sender
316i - 320i	E36, E46	95-99	4 Cyl	1.6L	231.125		
318i, 319S	E30	88-91	4 Cyl	1.8L	231.125		
318i	E36, E46	94-98	4 Cyl	1.8L	231.125		
320i	E30, E36	88-95	6 Cyl	2.0L	231.125		
320i	E30	82-85	6 Cyl	2.3L	231.109		
323i - 323Ci	E46	98-on	6 Cyl	2.5L	231.125		
325i - 325e	E30, E36	86-95	6 Cyl	2.5L, 2.7L	231.125		
325Ti - 325Ci	E46	02-on	6 Cyl	2.5L	231.125		
328i - 328Ci	E36, E46	95-00	6 Cyl	2.8L	231.125		
330i - 330Ci	E36	00-on	6 Cyl	3.0L	231.125		
520i	E28	83-85	6 Cyl	2.0L	231.109		
520i	E34	90-96	6 Cyl	2.0L	231.125		
523i	E39	96-00	6 Cyl	2.5L	231.125		
525i	E34	88-90	6 Cyl	2.5L	231.125		

VEHICLE SENDERS APPLICATION LISTING

BMW Continued					Light	Gauge	Gauge
Make/Series	Model	Year	Engine	Capacity	Oil Switch	Temp Sender	Pressure Sender
528i	E28	82-85	6 Cyl	2.8L	231.109		
528i	E39	96-00	6 Cyl	2.8L	231.125		
530i	E34	93-96	8 Cyl	3.0L	231.125		
530i	E60	03-on	6 Cyl	3.0L	231.125		
530i	E28	86-88	6 Cyl	3.4L	231.109		
535i	E28	86-88	6 Cyl	3.4L	231.109		
535i & 535iS	E34	88-91	6 Cyl	3.4L	231.125		
535i	E39	96-on	8 Cyl	3.5L	231.125		
540i	E34	94-96	8 Cyl	4.0L	231.125		
540i	E39	96-03	8 Cyl	4.0L	231.125		
545i	E39	03-on	8 Cyl	4.0L	231.125		
730i	E32	86-94	6 Cyl	3.0L	231.125		
730i	E32 iL	91-94	8 Cyl	3.0L	231.125		
740iL	E32, E38	92-on	8 Cyl	4.0L & 4.4L	231.125		
745iL	E66 LWB	02-on	8 Cyl	4.4L	231.125		
M3, M3R	E36, E46	94-on	6 Cyl	3.0L & 3.2L	231.125		
X3, X5, Z3	E83, E53, E36	97-on	4 Cyl, 6 Cyl, 8 Cyl	1.9L 2.0L, 3.0L, 4.4L, 4.6L	231.125		
Z4	2D Convertible	03-on	6 Cyl	2.5L & 3.0L	231.125		

CHRYSLER					Light	Gauge	Gauge
Make/Series	Model	Year	Engine	Capacity	Oil Switch	Temp Sender	Pressure Sender
Valiant	All	62-81	6 Cyl, 8 Cyl	All	231.083	320.002	360.001
Charger	All	62-81	6 Cyl, 8 Cyl	All	231.083	320.002	360.001
Centura	KB	75-77	4 Cyl	2.0L	230.089		
Centura	KB, KC	75-78	6 Cyl	3.5L, 4.0L	231.083		
Galant	All	71-77	4 Cyl	All	231.083		

DAEWOO					Light	Gauge	Gauge
Make/Series	Model	Year	Engine	Capacity	Oil Switch	Temp Sender	Pressure Sender
1.5i		94-95	4 Cyl	1.5L	231.096	320.008	
Cielo	1.5 SOHC	94-95	4 Cyl	1.5L		320.008	
Cielo	1.5 SOHC, 1.5 DOHC	95-98	4 Cyl	1.5L	231.096	320.095	
Espero	2.0L SOHC	95-97	4 Cyl	2.0L	231.096		
Kalos	1.5L SOHC	03-04	4 Cyl	1.5L	231.148	320.098	
Lacetti	1.8L DOHC	03-04	4 Cyl	1.8L	231.148	320.095	
Lanos	1.5L SOHC, 1.6 DOHC	97-03	4 Cyl	1.5L	231.114	320.095	
Leganza	2.0L DOHC	97-99	4 Cyl	2.0L	231.114	320.095	
Leganza	2.2L DOHC	99-02	4 Cyl	2.2L	231.114	320.095	
Matiz	KL M100 SOHC	99-01	3 Cyl	0.8L	231.089	320.095	
Matiz	KL M150 SOC	02-04	3 Cyl	0.8L		320.095	
Musso	3.2L DOHC	98-02	6 Cyl	3.2L	231.094		
Nubira	J100	97-99	4 Cyl	1.6L	231.114	320.098	
Nubira	J100	97-99	4 Cyl	2.0L	231.114	320.099	
Nubira	J150	99-03	4 Cyl	2.0L	231.114	320.095	
Tacuma	Wagon 16DOHC	00-04	4 Cyl	2.0L		320.095	

VEHICLE SENDERS APPLICATION LISTING

DAIHATSU					Light	Gauge	Gauge
Make/Series	Model	Year	Engine	Capacity	Oil Switch	Temp Sender	Pressure Sender
Applause	A101	89-99	4 Cyl	1.6L	231.084		
Charade	G10, G11, G11 Turbo	80-87	3 Cyl	1.0L	231.084	320.068	
Charade	G100, G100 Turbo	87-93	3 Cyl	1.0L	231.084	320.068	
Charade	G102	88-93	4 Cyl	1.3L	231.084	320.068	

FORD					Light	Gauge	Gauge
Make/Series	Model	Year	Engine	Capacity	Oil Switch	Temp Sender	Pressure Sender
Bronco		81-85	6 Cyl	4.1L			
Bronco		81-85	8 Cyl	5.8L			
Bronco		85-87	8 Cyl	4.9L			
Capri	All	74-84	4 Cyl, 6 Cyl	1.6L, 3.0L	231.137	320.067	
Courier	PC 4WD	87-98	4 Cyl	2.6L	231.084	320.067	
Courier	PE, PG, PH	99-on	4 Cyl	2.6L	231.084	320.067	
Courier	PH	99-on	4 Cyl	2.6L	231.084	320.067	
Econovan	1.4L, 1.8L	84-97	4 Cyl	1.4L, 1.8L	231.084	320.041	
Econovan	1.6L	84-97	4 Cyl	1.6L	231.084	320.068	
Econovan	1.8L, 2.0L	03-06	4 Cyl	1.8L, 2.0L	231.089	320.067	
Econovan	Diesel	81-84	4 Cyl	2.2L	231.084	320.068	
Econovan	Diesel	84-90	4 Cyl	2.2L	231.084	320.041	
Econovan	Diesel	90-97	4 Cyl	2.2L	231.084	320.067	
Escort	All, Mk1, Mk2	70-81	4 Cyl	1.6L, 2.0L	231.137	320.003	
Explorer	UN, UP, UQ, US	96-01	6 Cyl	4.0L			
F100, F250, F350	RWD, 4WD	70-90	6 Cyl	4.1L	231.106		
F100	4WD EFI, RWD EFI	85-87	8 Cyl	4.9L	231.106		
F150	4WD EFI, RWD EFI,	87-90	8 Cyl	4.9L	231.106		
F250	RWD Carb,	87-90	8 Cyl	4.9L	231.106		
F350	RM RWD EFI	01-02	8 Cyl	5.4L	231.106		
F100, F350	4WD Carb, RWD Carb	78-85	8 Cyl	5.8L			
F150	4WD EFI, RWD EFI,	90-92	8 Cyl	5.8L			
F250, F350	RWD Carb, 4WD EFI	91-93	8 Cyl	5.8L			
F350	RWD Turbo Diesel	01-03	8 Cyl	7.3L			
Fairlane	ZA, ZG	67-76	6 Cyl, 8 Cyl	4.1L, 4.9L	231.081	320.003	
Fairlane	ZJ, ZK, EFI, Carb.	79-83	6 Cyl, 8 Cyl	4.1L, 4.9L	231.106		
Fairlane	ZH	76-79	8 Cyl	4.9L, 5.8L	231.081		360.003
Fairlane	ZL Leaded	84-86	6 Cyl	4.1L	231.106	320.003	
Fairlane	ZL Unleaded	86-88	6 Cyl	4.1L	231.106	320.003	
Fairlane	NA, NC, NF, NL	88-98	6 Cyl	3.9L, 4.0L	231.081	320.065	
Fairlane	NC, NF, NL	91-98	8 Cyl	5.0L	231.106		
Fairlane	AU, AU II	99-02	6 Cyl	3.9L, 4.0L	231.081		
Fairlane	BA, BF, XR6, XR8, UTE	03-07	6 Cyl, 8 Cyl	4.0L, 5.0L	231.100		360.001 (POD)
Falcon	XK, XP, XR, XT, XW, XY	60-72	6 Cyl, 8 Cyl	All	231.081		
Falcon	XL, XM,	61-65	6 Cyl	All	231.081		
Falcon	XT Carb, XW Carb, XW GTHO Phase 1 & 2, XY Carb, XY GTHO Phase 3	68-72	8 Cyl	5.0L, 5.8L, 4.9L	231.081		
Falcon	XA, XB, XC, XC Carb	72-79	6 Cyl, 8 Cyl	All	231.081	320.003	360.003

VEHICLE SENDERS APPLICATION LISTING

FORD Continued					Light	Gauge	Gauge
Make/Series	Model	Year	Engine	Capacity	Oil Switch	Temp Sender	Pressure Sender
Falcon	XD, XE, UTE	79-84		3.3L, 4.1L	231.106	320.011	360.013
Falcon	XF, UTE, EFI Carb	84-88	6 Cyl	4.1L	231.106	320.011	360.013
Falcon	EA, EA II, EB, ED	89-94	6 Cyl, 8 Cyl	3.2L, 3.9L, 4.0L, 5.0L	231.106	320.065	360.013
Falcon	EF, EFII, EL	94-98	6 Cyl	4.0L	231.106	320.065	360.045
Falcon	EF, EFII, EL	94-98	8 Cyl	5.0L	231.106		360.045
Falcon	AU, AUII, AUIII, UTE, XR6, XR6 UTE	98-02	6 Cyl,	4.0L	231.106		360.045
Falcon	AU, AUII, AUIII, XR8, UTE, XR8 UTE, AU TE50	98-02	8 Cyl	5.0L	231.106		360.045
Falcon	BA, XR6 Turbo, RTV, Ute	02-05	6 Cyl	4.0L	231.100		360.045
Falcon	BA SOHC, XR8 DOHC, Pursuit Ute DOHC	02-05	8 Cyl	5.4L	231.100		
Falcon	BF SOHC/DOHC	05-06	6 Cyl, 8 Cyl	4.0L, 5.4L	231.100		
Falcon	BF Turbo	05-06	6 Cyl	4.0L	231.100		
Falcon	BF MKII	05-06	6 Cyl	4.0L	231.100		
Falcon	BF MKII	06-08	8 Cyl	5.4L	231.100		
Falcon	FG, FG G6 (LPG), FG F6E (Turbo)	08-on	6 Cyl	4.0L	231.100		
Falcon	FG XR8	08-on	8 Cyl	5.4L	231.100		
Falcon	XH Ute / Van	96-98	6 Cyl, 8 Cyl	4.0L, 5.0L	231.106		
Festiva	WA	91-93	4 Cyl	1.3L	231.084		
Festiva	WA	93-94	4 Cyl	1.3L	231.084		
Festiva	WB, WD	94-97	4 Cyl	1.3L	231.102		
Festiva	WF	94-03	4 Cyl	1.3L	231.084 231.102		
Festiva	WD, WF	97-01	4 Cyl	1.5L	231.102		
Fiesta	WP, LX, Zetc, Ghia	04-05	4 Cyl	1.6L, 2.0L	231.137		
Fiesta	WQ, LX, Zetec, Ghia	06-08	4 Cyl	1.6L, 2.0L	231.137		
Fiesta Turbo	WS Turbo Diesel, WT Turbo Diesel	09-on	4 Cyl	1.6L	231.147		
Focus	LT, LV Turbo Diesel	07-on	4 Cyl	2.0L	231.147		
Ka	TA, TB	99-02	4 Cyl	1.3L	231.137		
Laser	KA, KB, KC, KF, TX3, 4WD	81-91	4 Cyl	1.6L	231.084	320.067	
Laser	KC, KH, KJ, TX3	91-99	4 Cyl	1.6L	231.082		
Laser	KA, KB Incl Turbo	81-85	4 Cyl	1.3L, 1.5L	231.129	320.067	
Laser	KC, KC Carb	85-87	4 Cyl	1.3L	231.129	320.067	
Laser	KC Carb	85-87	4 Cyl	1.6L	231.084	320.067	
Laser	KE Carb	87-90	4 Cyl	1.3L	231.129	320.067	
Laser	KE Carb, EFI	87-90	4 Cyl	1.6L	231.084	320.041	
Laser	KE Carb, EFI	89-90	4 Cyl	1.6L	231.084	320.067	
Laser	KE EFI Turbo, EFI 16V 4x4 Turbo	87-90	4 Cyl	1.6L	231.129	320.067	
Laser	KE EFI Turbo, EFI 16V 4x4 Turbo	88-90	4 Cyl	1.6L	231.129	320.067	
Laser	KF Carb, EFI, EFI 16V	90-91	4 Cyl	1.6L, 1.8L	231.089	320.097	
Laser	KF EFI Turbo	90-91	4 Cyl	1.8L	231.102	320.097	
Laser	KH, TX3 EFI	91-94	4 Cyl	1.6L	231.089	320.097	
Laser	KH TX3 EFI Turbo	91-93	4 Cyl	1.8L	231.084	320.097	
Laser	KJ EFI	94-96	4 Cyl	1.6L	231.089	320.097	
Laser	KJ EFI	96-98	4 Cyl	1.6L, 1.8L	231.089		
Laser	KJ EFI	94-96	4 Cyl	1.8L	231.089	320.097	
Laser	KN	99-01	4 Cyl	1.6L	231.089		

VEHICLE SENDERS APPLICATION LISTING

FORD Continued					Light	Gauge	Gauge
Make/Series	Model	Year	Engine	Capacity	Oil Switch	Temp Sender	Pressure Sender
Laser	KN	99-01	4 Cyl	1.8L	231.089		
Laser	KQ	01.02	4 Cyl	1.6L, 1.8L, 2.0L	231.089		
LTD	FD	83-84	6 Cyl	4.1L	231.106		
LTD	FE	84-88	6 Cyl	4.1L	231.106		
LTD	DA (MPI)	88-91	6 Cyl	3.9L	231.106		
LTD	DC	91-94	6 Cyl, 8 Cyl	4.0L, 5.0L	231.106		
LTD	DF	94-96	6 Cyl, 8 Cyl	4.0L, 5.0L	231.106		360.045
LTD	DL	96-98	6 Cyl, 8 Cyl	4.0L, 5.0L	231.106		360.045
LTD	AU, AU II	98-02	6 Cyl, 8 Cyl	4.0L, 5.0L	231.106		360.045
LTD	BA	03-05	6 Cyl, 8 Cyl	4.0L, 5.4L	231.100		
Maverick	(Carb)	88-93	6 Cyl	4.2L	231.116		
Meteor	GA, GB, GC	82-85	4 Cyl	1.5L, 1.6L	231.084		
Meteor	GC	85-87	4 Cyl	1.6L	231.084		
Mondeo	HA, HB, HC	95-98	4 Cyl	2.0L	231.137		
Probe	ST, SU, SV	94-98	V6	2.5L	231.089		
Raider	UV	91-96	4 Cyl	2.6L	231.089		
Spectron	2XLT	84-90	4 Cyl	1.8L, 2.0L	231.137		
Taurus	DN, DP	96-98	V6	3.0L	231.137		
Telstar	AR (Carb), AT(Carb)	83-89	4 Cyl	2.0L	231.084	320.067	
Telstar	AS Inc TX5, Turbo	85-87	4 Cyl	2.0L	231.084	320.067	
Telstar	AT EFI Inc TX5, Turbo	87-89	4 Cyl	2.2L	231.084	320.067	
Telstar	AV, AV EFI-Turbo	90-92	4 Cyl	2.2L	231.089		
Telstar	AX DOHC, AY DOHC	92-96	4 Cyl, 6 Cyl	2.0L, 2.5L	231.089		
Territory	SX, SY, SZ	04-10	6 Cyl	4.0L	231.100		
Trader	0409, 0509	79-89	4 Cyl	2.0L, 3.0L, 3.5L	231.084		
Trader	0711, 0811 Diesel	81-95	4 Cyl	4.1L	231.084		
Trader	0811, 0812, Turbo Diesel	87-92	4 Cyl	3.5L	231.084		
Transit		73-81	6 Cyl	4.1L	231.081		
Transit	VF, VG	96-01	4 Cyl	2.0L	231.137		
Transit	VH, VJ	01-05	4 Cyl	2.3L	231.137		

HOLDEN					Light	Gauge	Gauge
Make/Series	Model	Year	Engine	Capacity	Oil Switch	Temp Sender	Pressure Sender
Apollo	JK, JL Carb	89-93	4 Cyl	2.0L	231.102		
Apollo	JK, JL (EFI)	89-91	4 Cyl	2.0L	231.102		
Apollo	JM, JP	93-97	4 Cyl	2.2L	231.104		
Apollo	JM, JP	93-95	6 Cyl	3.0L	231.104		
Astra	LB, LC	84-89	4 Cyl	1.5L, 1.6L	231.087	320.039	
Astra	LD	87-89	4 Cyl	1.6L	231.087	320.039	
Astra	TR	96-98	4 Cyl	1.6L, 1.8L, 2.0L	231.114		
Astra	TS	98-04	4 Cyl	1.8L	231.114		
Astra	AH	04-on	4 Cyl	1.8L	231.114		
Barina	MB, MF, ML	85-91	4 Cyl	1.3L	231.084		
Barina	MH	91-94	4 Cyl	1.3L	231.084		
Barina	SB, Gsi	94-00	4 Cyl	1.2L, 1.4L, 1.6L	231.114		
Barina	XC, Sri, Combo	01-on	4 Cyl	1.4L, 1.6L, 2.0L	231.114		
Calibra	YE, Ecotec, Turbo, YE95 DOHC	91-97	4 Cyl, 6 Cyl	2.0L, 2.5L	231.114		

VEHICLE SENDERS APPLICATION LISTING

HOLDEN Continued					Light	Gauge	Gauge
Make/Series	Model	Year	Engine	Capacity	Oil Switch	Temp Sender	Pressure Sender
Camira	JB, JD, JE	82-89	4 Cyl	1.6L, 1.8L, 2.0L	231.087	320.033	360.015
Captiva	CG	06-on	6 Cyl	3.2L			360.015
Captiva Maxx	CG	07-on	6 Cyl	3.2L			360.015
Captiva Diesel	CG (SX, CX, LX)	07-on	4 Cyl	2.0L	231.114		
Colorado	RC	08-on	6 Cyl	3.6L			360.015
Colorado	RC	08-on	4 Cyl	2.4L	231.114		
Commodore	VC, VH	80-81	4 Cyl	1.9L	231.081	320.032	
Commodore	VB, VC, VH, VK EFI	78-86	6 Cyl	2.8L, 3.3L	231.081	320.032	360.004
Commodore	VB, VC, VH, VK EFI	78-86	8 Cyl	3.3L	231.081	320.024	360.004
Commodore	VL, VL Turbo	86-88	6 Cyl	3.0L	231.089		360.017
Commodore	VN, VP, VQ, VR	88-95	6 Cyl, 8 Cyl	3.8L, 5.0L	231.088	320.033	
Commodore	VS, VS Supercharged, Ute	95-96	6 Cyl	3.8L,	231.088	320.033	
Commodore	VS Series II	96-98	8 Cyl	5.0L	231.088	320.033	
Commodore	VT, VT I Supercharged, GTS	97-99	6 Cyl	3.8L,	231.088	320.033	
Commodore	VT	97-99	8 Cyl	5.0L	231.088	320.033	
Commodore	VT II	99-00	8 Cyl	GENIII LS1, 5.7L	231.088		
Commodore	Ute VG, VX, VY, VU	97-04	6 Cyl, 8 Cyl	3.8L, 5.0L	231.088		
Commodore	VX	00-01	6 Cyl	3.8L	231.088		
Commodore	VX	00-01	8 Cyl	5.7L	231.122		
Commodore	VX Series II	01-02	6 Cyl	3.8L	231.088		
Commodore	VX Series II	01-02	8 Cyl	5.7L	231.122		
Commodore	VY	02-03	6 Cyl	3.8L	231.088		
Commodore	VY	02-03	8 Cyl	5.7L	231.122		
Commodore	VY Series II	03-04	6 Cyl	3.8L	231.088		
Commodore	VY Series II	03-04	8 Cyl	5.7L	231.122		
Commodore	VZ	04-06	6 Cyl	3.6L	231.150		
Commodore	VZ	04-06	8 Cyl	5.7L,6.0L	231.122		
Commodore	VE	06-09	6 Cyl	3.6L	231.150		360.015 for ecu
Commodore	VE	06-09	8 Cyl	6.0L	231.122		
Commodore	VE Series II	09-13	6 Cyl	6.0L	231.150		
Commodore	VE Series II	09-13	8 Cyl	6.2L			
Epica	EP - Turbo Diesel	08-on	4 Cyl	2.0L	231.114		
Epica	EP	07-on	6 Cyl	2.0L, 2.5L	231.114		
Gemini	TX, TC, TE, TF, TG	75-85	4 Cyl	1.6L, 1.8L D	231.084	320.047	

VEHICLE SENDERS APPLICATION LISTING

HOLDEN Continued					Light	Gauge	Gauge
Make/Series	Model	Year	Engine	Capacity	Oil Switch	Temp Sender	Pressure Sender
Gemini	RB FWD	75-85	4 Cyl	1.6L, 1.8L D	231.084	320.047	
Drover	QB	85-87	4 Cyl	1.3L	231.089	320.044	
Holden	EH, HD, HR, HK, HT	53-68	6 Cyl	All	231.084	320.002	
Holden	HK, HT, HG, HQ	68-76	6 Cyl	All	231.084	320.002	360.004
Holden	HJ, HX, HZ, WB	76-85	8 Cyl	All	231.081	320.003	360.005
Frontera	UES30	98-04	4 Cyl	2.2L	231.114		
Jackaroo	UBS16, UBS17 Petrol, Diesel	85-92	4 Cyl	2.6L	231.084		
Jackaroo	UBS81, UBS521 Turbo Diesel	81-88	4 Cyl	2.2L	231.084		
Jackaroo	UBS55 Turbo Diesel	88-92	4 Cyl	2.8L	231.084		
Jackaroo	UBS69 Turbo Diesel	92-98	4 Cyl	3.1L	231.084		
Jackaroo	UBS73 Turbo Diesel	98-04	4 Cyl	3.0L	231.084		
Monaro	VX, VY, CV6 Supercharged	01-04	6 Cyl	3.8L	231.088	320.032	360.004
Monaro	VY	02-04	8 Cyl	GENIII LS1, 5.7	231.122		
Monaro	VZ	04-06	8 Cyl	GENIII LS1, 5.7	231.122		
Nova	LE, LF, EFI	89-94	4 Cyl	1.4L, 1.6L, 1.8L	231.084		
Rodeo	KB25, KB26, KB40, KB41	78-82	4 Cyl	1.4L, 1.6L	231.084	320.032	
Rodeo	KB47, KB48, KB49	83-84	4 Cyl	1.8L, 1.9L, 2.3L	231.084	320.032	
Rodeo	KB43, KB49	85-88	4 Cyl	2.3L	231.084		
Rodeo	TFR54, TFS54	88-93	4 Cyl	2.5L	231.084		
Rodeo	TFR25	98-98	4 Cyl	2.3L	231.084		
Rodeo	TFR26	98-03	4 Cyl	2.2L	231.114		
Rodeo	Diesel	79-82	4 Cyl	2.0L	231.084		
Rodeo	KBD42, KBD43, KBD47	83-88	4 Cyl	2.0L	231.084	320.067	
Rodeo	KBD27, KBD28	83-88	4 Cyl	2.2L	231.084		
Rodeo	Diesel	91-01	4 Cyl	2.8L	231.084	320.042	
Rodeo	RA03	03-on	4 Cyl	3.0L	231.084		
Rodeo	RA	03-06	4 cyl	2.4L	231.114		
Rodeo	RA Turbo Diesel	03-06	4 cyl	3.0L	231.084		
Rodeo	RA	03-06	6 cyl	3.5L	231.086	320.044	
Rodeo	RA	06-08	6 cyl	3.6L			360.015
Rodeo	RA07	07-08	4 Cyl	2.4L	231.114		
Rodeo	RA07	07-08	6 Cyl	3.6L			360.015
Statesman	VQ	90-94	8 Cyl	5.0L	231.088		
Statesman	VR	93-95	6 Cyl, 8 Cyl	3.8L, 5.0L, 5.7L	231.088		
Statesman	VS	95-96	6Cyl, 8Cyl	3.8L, 5.0L, 5.7L	231.088		
Statesman	WH	99-01	6 Cyl	3.8L	231.088		
Statesman (Inc Grange)	WH	99-01	8 Cyl	GENIII LS1, 5.7	231.122		
Statesman (Inc Grange)	WH Series II	01-03	8 Cyl	GENIII LS1, 5.7	231.122		
Statesman	WK	03-04	6 Cyl	3.8L	231.088		
Statesman	WK	03-04	8 Cyl	5.7L	231.122		
Statesman	WL	04-06	6 Cyl	3.6L	231.150		360.015
Statesman	WL	04-06	8 Cyl	5.7L	231.122		
Statesman	WL	04-06	8 Cyl	6.0L	231.122		

VEHICLE SENDERS APPLICATION LISTING

HOLDEN Continued					Light	Gauge	Gauge
Make/Series	Model	Year	Engine	Capacity	Oil Switch	Temp Sender	Pressure Sender
Statesman	WM - I + II	06-10	6 Cyl	3.6L	231.150		360.015
Statesman	WM - I + II	06-10	8 Cyl	6.0L, 6.2L	231.122		
Suburban	FK1	01-02	8 Cyl	5.7L			
Sunbird	LX, UC	76-80	4 Cyl	1.9L	231.081	320.004	
Tigra	XC	05-on	4 Cyl	1.8L			
Torana	LH, LX	74-76	4 Cyl	1.9L	231.087	320.003	
Torana	LC, LH, LJ, LX, UC	69-79	6 Cyl	All	231.081		
Torana	LH, LX	69-79	8 Cyl	All	231.081		360.005
Vectra	JR	97-98	4 Cyl, 6 Cyl	2.0L, 2.5L	231.114		
Vectra	JS	98-00	4 Cyl	2.0L, 2.2L	231.114		
Vectra	JS	98-00	6 Cyl	2.5L	231.114		
Vectra	JS II	00-01	4 Cyl, 6 Cyl	2.2L, 2.6L	231.114		
Vectra	ZC	03-05	4 Cyl, 6 Cyl	2.2L, 3.2L	231.114		
Zafira	TT	00-05	4 Cyl	2.2L	231.114		

HONDA					Light	Gauge	Gauge
Make/Series	Model	Year	Engine	Capacity	Oil Switch	Temp Sender	Pressure Sender
Accord	SJD, SJFR	77-78	4 Cyl	1.6L	231.086	320.068	
Civic	ED, EE	87-91	4 Cyl	1.5L	231.086	320.068	
Civic	EG, EH	91-95	4 Cyl	1.5L, 1.6L	231.086	320.068	
Civic	EK4, VTi R	91-95	4 Cyl	1.5L, 1.6L	231.086	320.068	
Concerto	MA EX-I	88-93	4 Cyl	1.6L	231.086	320.068	
Legend	KA7, KA8, KA9	91-96	6 Cyl	2.7L, 3.2L	231.102	320.068	
Legend	KA9	96-05	6 Cyl	3.5L	231.102		
Odyssey	RA1	95-97	4 Cyl	2.2L	231.086	320.068	
Prelude	BA8, BB2	91-96	4 Cyl	2.2L, 2.3L	231.086	320.068	

HYUNDAI					Light	Gauge	Gauge
Make/Series	Model	Year	Engine	Capacity	Oil Switch	Temp Sender	Pressure Sender
Accent		00-02	4 Cyl	1.5L	231.089	320.067	
Accent	LC,LS	00-06	4 Cyl	1.6L	231.089		
Accent	MC	06-09	4 Cyl VVT	1.6L	231.089		
Coupe RD, RDII	FX, SX, SFX	96-02	4 Cyl	1.8L, 2.0L	231.089	320.067	
Elantra	XD	00-03	4 Cyl	1.8L, 2.0L	231.089		
Elantra	XD MY04	03-06	4 Cyl	2.0L	231.089		
Elantra Elite	HD	06-on	4 Cyl VVT	2.0L	231.089		
Elantra	Lavita	01-03	4 Cyl	1.8L	231.089		
Excel	X1 (Carb)	86-89	4 Cyl	1.5L	231.089	320.067	
Excel	X2,	90-94	4 Cyl	1.5L	231.089	320.067	
Excel	X3 SOHC	94-98	4 Cyl	1.5L	231.089	320.067	
Excel	X3, DOHC	98-00	4 Cyl	1.4L	231.089		
Getz	TB	02-05	4 Cyl	1.5L	231.089	320.067	
Getz	TB	03-05	4 Cyl	1.3L	231.089		
Getz	TB MY06	05-07	4 Cyl	1.4L	231.089		
Getz	TB MY06	05-on	4 Cyl	1.6L	231.089		
Getz	TB SXi	06-on	4 Cyl	1.6L	231.089		
Lantra	KF2, KF3	91-95	4 Cyl	1.6L, 1.8L	231.137	320.044	

VEHICLE SENDERS APPLICATION LISTING

HYUNDAI Continued					Light	Gauge	Gauge
Make/Series	Model	Year	Engine	Capacity	Oil Switch	Temp Sender	Pressure Sender
Lantra	J2	95-98	4 Cyl	1.8L	231.137	320.044	
Lantra	L3	99-00	4 Cyl	1.8L, 2.0L	231.089	320.067	
Santa - Fe	CM	06-09	4 Cyl Turbo Diesel	2.2L	231.089		
S-Coupe	UE2, UE3	90-91	4 Cyl	1.5L	231.137	320.044	
S-Coupe	UE3, UE4	92-95	4 Cyl	1.5L	231.137	320.044	
S-Coupe	UE3, UE4	92-95	4 Cyl	1.5L	231.089	320.044	
Sonata	AF2, AF3	89-92	4 Cyl	2.4L	231.089	320.067	
Sonata	AF2, AF3	90-93	4 Cyl	2.4L	231.089	320.044	
Sonata	DF2, DF4	93-96	4 Cyl	2.0L	213.137	320.044	320.044
Sonata	DF3, DF4	93-98	6 Cyl	3.0L	231.121	320.044	
Sonata	EF	98-00	4 Cyl	2.0L	231.089	320.067	
Sonata	EF	98-01	6 Cyl	2.5L	231.089	320.067	
Sonata	EF-B	01-05	4 Cyl	2.4L		320.044	
Trajet	GLS Wagon	00-07	6 Cyl	2.7L	231.089		
Tucson	Elite Wagon	04-on	4 Cyl, 6 Cyl	2.0L, 2.7L	231.089		

KIA							
Make/Series	Model	Year	Engine	Capacity	Oil Switch	Temp Sender	Pressure Sender
Carens	DOHC Wagon	00-02	4 Cyl	1.8L	231.102		
Carnival	UP	99-06	6 Cyl	2.5L	231.121	320.067	
					231.102		
Credos	GC	98-01	4 Cyl	2.0L	231.102	320.067	
Pregio Van		02-on	4 Cyl	2.7L	231.089	320.067	
Rio	BC	00-on	4 Cyl	1.5L	231.102		
Shuma	FB	99-01	4 Cyl	1.8L	231.102	320.067	
Spectra	5D Hatch	01-04	4 Cyl	1.8L	231.102		
Sportage	JA	96-04	4 Cyl	2.0L	231.102	320.067	

LAND ROVER				Light	Gauge	Gauge	Pressure
Make/Series	Model	Year	Engine	Capacity	Oil Switch	Temp Sender	Sender
Defender	110 Turbo-Diesel	92-99	4 Cyl	2.5L	231.140		
Defender	90, 110, 130, TD5	99-on	5 Cyl	2.5L	231.116		
Discovery	TDi BF, MF	92-98	4 Cyl	2.5L	231.140		
Freelander	1.8L	98-03	4 Cyl	1.8L	231.125		
Freelander	1.8L, 2.5L	98-03	6 Cyl	2.5L	231.125		
Range Rover	SE, HSE, TD6	02-on	6 Cyl	2.6L	231.125		
Range Rover	HSE, Vouge	02-on	8 Cyl	4.4L	231.125		

LEXUS					Light	Gauge	Gauge
Make/Series	Model	Year	Engine	Capacity	Oil Switch	Temp Sender	Pressure Sender
ES300	VCV10R	92-96	6 Cyl	3.0L	231.104	320.067	
ES300	MCV20R	96-on	6 Cyl	3.0L	231.104	320.088	
GS300	JZS160R	97-05	6 Cyl	3.0L	231.104		
IS200	GXE10R	99-on	6 Cyl	2.0L	231.104		

VEHICLE SENDERS APPLICATION LISTING

LEXUS Continued					Light	Gauge	Gauge
Make/Series	Model	Year	Engine	Capacity	Oil Switch	Temp Sender	Pressure Sender
LS400	UCF10R, UCF20R	90-00	8 Cyl	4.0L	231.104		
LS430		00-on	8 Cyl	4.3L	231.104		
RX330	MCU38R	03-on	6 Cyl	3.3L	231.104		

MAZDA					Light	Gauge	Gauge
Make/Series	Model	Year	Engine	Capacity	Oil Switch	Temp Sender	Pressure Sender
1.2L - 1.8L,		68-77	4 Cyl	1.5L, 1.6L, 1.8L	231.084		
B1500, B1600	Petrol	70-82	4 Cyl	1.5L, 1.6L, 1.8L	231.084		
B1800	Petrol	70-82	4 Cyl	1.5L, 1.6L, 1.8L	231.084		
B2000	Petrol	82-88	4 Cyl	2.0L	231.084		
B2200	Bravo Incl. MANUAL (Carb)	88-93	4 Cyl	2.2L	231.102		
B2200	Bravo Incl. AUTO	88 -91	4 Cyl	2.2L	231.102		
B2500, B2600	RWD, 4WD, Diesel, Turbo Diesel	96-on	4 Cyl	2.5L, 2.6L	231.102		
B2600 EFI	Bravo, 4WD	90-02	4 Cyl	2.6L	231.084		
Capella		70-78	4 Cyl	1.6L	231.084		
E1300, E1400		78-86	4 Cyl	1.3L, 1.5L	231.084		
E1600		78-86	4 Cyl	1.6L	231.084		
E2000		98-on	4 Cyl	2.0L	231.102		
E2500		97-on	4 Cyl	2.5L	231.102		
121	CD2	76-79	4 Cyl	1.8L	231.084	320.068	
121	DA	87-90	4 Cyl	1.3L	231.102	320.088	
121	DB1031,	90-97	4 Cyl	1.3L	231.102	320.088	
323	FA, BD, BF, BW, 4WD, Turbo	77-89	4 Cyl	1.3L, 1.5L, 1.6L	231.102		
323	BG, BJ, Astina, Protege'	89-04	4 Cyl	1.6L, 1.8L	231.102	320.067	
626	CB2	78-83	4 Cyl	2.0L	231.084	320.041	
626	GC Diesel, GD-Turbo	84-91	4 Cyl	2.0L, 2.2L	231.084	320.041	
626	GV10-Wagon, GE, GF	88-02	4 Cyl	2.0L, 2.2L	231.102	320.067	
626	GE	92-97	6 Cyl	2.5L	231.102	320.067	
808		72-78	4 Cyl	1.3L, 1.6L	231.084		
929	HBSHE	82-87	4 Cyl	2.0L	231.084	320.041	
929	HC10E1, HC10E2	87-91	6 Cyl	3.0L	231.084	320.041	
929	HC10E2 - 4WS	90-96	6 Cyl	3.0L	231.102	320.067	
MPV	LV	93-94	6 Cyl	3.0L	231.084	320.067	
MPV	LV II	94-99	6 Cyl	3.0L	231.084	231.067	
MX5	NA (DOHC)	93-98	4 Cyl	1.8L	231.102	320.067	
MX5	NB (DOHC), Incl Turbo	98-05	4 Cyl	1.8L	231.102	320.067	
MX6	GD Turbo, 2WD, 4WD	87-97	4 Cyl, 6 Cyl	2.0L, 2.2L, 2.5L	231.102	320.067	
MX6	GE10, GE20, 2WD, 4WD	94-97	4 Cyl, 6 Cyl	2.0L, 2.2L, 2.5L	231.102	320.067	
Premacy	CP Wagon	01-03	4 Cyl	1.8L	231.102		
R100		69-71	Rotary Eng		231.084		
RX2, 3, 4, 5		70-79	Rotary Eng	1.1L, 1.3L	231.084		
RX7	SA22 Series 1, 2, 3	79-85	Rotary Eng	1.1L	231.084		
RX7	FC10 IV	86-89	Rotary Eng	1.3L		320.067	
T2000		81-82	4 Cyl	2.0L	231.089	320.067	
T3500, T4000	Diesel, Turbo	84-00	4 Cyl, 6 Cyl	3.5L, 4.0L	231.084	320.067	
T4100	Diesel	84-91	4 Cyl	4.0L, 4.1L	231.089	320.067	
T4600	Diesel	92-on	4 Cyl	4.6L	231.084	320.067	
Traveller	L, LX, LT, 1800, 2000	86-88	4 Cyl	1.8L	231.089		

VEHICLE SENDERS APPLICATION LISTING

EUNOS-MAZDA					Light	Gauge	Gauge
Make/Series	Model	Year	Engine	Capacity	Oil Switch	Temp Sender	Pressure Sender
30X	EC DOHC	96-97	6 Cyl	1.8L	231.102	320.067	
500	CA	92-96	6 Cyl	2.0L	231.102	320.044	
500	CA	96-99	6 Cyl	2.0L	231.102	320.067	
800	TA	94-96	6 Cyl	2.5L	231.089	320.038	
800M	TA	94-96	6 Cyl	2.3L		320.038	
800M	TA3, TA5, TB3	96-00	6 Cyl	2.3L	231.102	320.067	
Millenia		00-02	6 Cyl	2.3L	231.102	320.067	

MERCEDES-BENZ					Light	Gauge	Gauge
Make/Series	Model	Year	Engine	Capacity	Oil Switch	Temp Sender	Pressure Sender
190	E 1.8, E 2.0, E 2.3	82-87	4 Cyl	1.8L, 2.0L, 2.3L	231.087	320.035	360.021
190, 190D	E 1.8, E 2.0, E 2.3	88-93	4 Cyl	1.8L, 2.0L, 2.3L	231.087	320.035	360.021
200D, 220D, 240D, 140, 160	E, CE, TD, TE	74-86	4 Cyl	1.8L, 2.0L, 2.3L	231.087	320.002	360.021

MG					Light	Gauge	Gauge
Make/Series	Model	Year	Engine	Capacity	Oil Switch	Temp Sender	Pressure Sender
MG, MGA		45-62	4 Cyl, 6 Cyl	1.6L, 1.8L	231.083	320.046	
MGB, MGC		61-79	6 Cyl, 8 Cyl	1.8L, 3.0L, 3.5L	231.083	320.046	
MGF	TF	97-on	4 Cyl	1.8L	231.125		

MITSUBISHI					Light	Gauge	Gauge
Make/Series	Model	Year	Engine	Capacity	Oil Switch	Temp Sender	Pressure Sender
3000 GT		92-96	6 Cyl	3.0L	231.102	320.044	
Fuso Canter	FC212, FC432	81-92	4 Cyl	2.6L	230.089	320.067	
Challenger		98-on	6 Cyl	3.0L, 3.5L	230.089	320.067	
Colt	RA, RB, RC	80-84	4 Cyl	1.4L, 1.5L	230.089	320.036	
Colt	RC, RD, RE	84-90	4 Cyl	1.4L, 1.5L	231.102	320.036	
Galant	HG	89-90	4 Cyl	2.0L	231.102	320.044	
L200	MA, MB, MD 4WD	79-86	4 Cyl	2.0L, 2.3L	230.089		
L200	MC, MD	82-86	4 Cyl	1.6L	231.102		
L300 Express	SA, SB, SC, SD, SE 4WD	80-86	4 Cyl	1.6L, 1.8L	231.102		
Starwagon	SJ, 4WD, EFI, Diesel	86-94	4 Cyl	2.0L, 2.4L	231.102		
Starwagon	SF (EFI), SG (EFI), SH(EFI)	86-94	4 Cyl	2.4L	231.102		
Express / Starwagon	SF, SG, SH, SJ, 4WD, EFI, Diesel	86-94	4 Cyl	2.0L, 2.4L	231.102		
Express/ Starwagon	SJ	94-04	4 Cyl	2.0L, 2.4L	231.102	320.044	
Express/ Starwagon	WA, EFI	94-98	4 Cyl, 6 Cyl	2.0L, 2.4L, 3.0L	231.102	320.044	
Lancer	CA, CB, CC	88-96	4 Cyl	1.5L, 1.6L, 1.8L	231.102	320.044	
Lancer	CC	92-96	4 Cyl	1.8L	231.102	320.067	
Lancer	CE, CG	96-04	4 Cyl	1.5L, 1.6L, 1.8L	231.102	320.067	
Magna	TM, TN, TP, TR	85-94	4 Cyl	2.6L	231.084	320.067	
Magna	TM, TN, TP, TR	85-94	6 Cyl	3.0L	231.102	320.067	
Magna	TS Carb, TS EFI	94-97	4 Cyl	2.6L	231.084	320.044	
Magna	TS, EFI	94-97	6 Cyl	3.0L	231.102	320.044	

VEHICLE SENDERS APPLICATION LISTING

MITSUBISHI Continued					Light	Gauge	Gauge
Make/Series	Model	Year	Engine	Capacity	Oil Switch	Temp Sender	Pressure Sender
Magna	TE, TF, EFI	96-97	4 Cyl	2.4L	231.089	320.067	
Magna	TF, EFI	97-99	6 Cyl	3.0L	231.102	320.067	
Magna	TH, TJ	99-03	6 Cyl	3.0L, 3.5L	231.102	320.067	
Magna	TL, TW	03-04	6 Cyl	3.0L	231.102	320.067	
Mirage	CE	96-05	4 Cyl	1.5L	231.089	320.067	
Nimbus	UA, UB	84-87	4 Cyl	2.0L	231.102	320.038	
Nimbus	UC	87-92	4 Cyl	2.0L	231.089	320.038	
Nimbus	UC	87-92	4 Cyl	2.0L	231.102	320.038	
Nimbus	UF	92-98	4 Cyl	2.4L	231.102	320.038	
Nimbus	UG	98-04	4 Cyl	2.4L	231.089	320.067	
Outlander	ZE, LS-XLS	03-04	4 Cyl	2.4L	231.089	320.067	
Pajero	NA, NB, NC, ND	83-87	4 Cyl	2.6L	231.102		
Pajero	ND Auto	86-87	4 Cyl	2.6L	231.102	320.038	
Pajero	NE, NF, NG	87-91	4 Cyl	2.6L	231.102	320.038	
Pajero	NK,	96-00	6 Cyl	3.5L	231.102	320.067	
Pajero	NL	96 -00	6 Cyl	3.0L, 3.5L	231.102	320.067	
Pajero	NJ	93-96	6 Cyl	2.8L	231.102	320.044	
Pajero	NH, Intercooler	91-93	6 Cyl	2.5L	231.102		
Pajero iO	QA	99-03	4 Cyl	1.8L	231.102		
Scorpion	GE	78-79	4 Cyl	2.0L	231.089		
Scorpion	GJ, GK, GL	80-85	4 Cyl	2.6L	231.089		
Sigma	GE, GH, GJ, GK	77-85	4 Cyl	1.6L, 2.0L	231.102		
Sigma	GK, GN	84-87	4 Cyl	1.6L, 2.0L	231.102		
Triton	ME, MF, MG, MH, MJ, Petrol	86-94	4 Cyl	2.6L	231.102		
Triton	ME, MF, MG, MH, MJ, Diesel	86-96	4 Cyl, 6 Cyl	2.5L, 3.0L	231.102		
Triton	MH, MJ, 4WD	90-96	6 Cyl	3.0L	231.102	320.038	
Triton	MK, 4WD	96-05	6 Cyl	3.0L	231.089	320.067	
Verada	KR, KS	91-94	6 Cyl	3.0L	231.102		
Verada	KE, KF, KH, KJ, KL, KW	96-05	6 Cyl	3.0L, 3.5L	231.089		

NISSAN					Light	Gauge	Gauge
Make/Series	Model	Year	Engine	Capacity	Oil Switch	Temp Sender	Pressure Sender
120Y	B210	74-79	4 Cyl	1.2L	231.086		
180B, 200B	610, 810	72-81	4 Cyl	1.8L	231.086		
240, 260, 280	C, K, Z, ZX	70-84	6 Cyl	2.4L, 2.6L, 2.8L	231.086		
300ZX	Z31 Turbo	84-89	6 Cyl	3.0L	231.086		
520, 620, 720	RWD, FWD, Petrol, Diesel	71-85	4 Cyl	1.5L, 1.8L, 2.2L, 2.3L	231.086		
Bluebird	Series I, II	81-85	4 Cyl	2.0L	231.089		
Gazelle	S12	84-88	4 Cyl	2.0L	231.086		
Infinity	Q45	93-97	8 Cyl	4.5L	231.089	320.039	
Maxima	J30 SOHC FWD	90-92	6 Cyl	3.0L	231.089		
Maxima	A31 SOHC FWD	93-95	6 Cyl	3.0L	231.089	320.039	
Maxima	A32 DOHC FWD	95-99	6 Cyl	3.0L	231.089	320.096	
Maxima	A33 DOHC FWD	99-03	6 Cyl	3.0L	231.089	320.096	
Micra	K11E	95-97	4 Cyl	1.3L	231.089		
Navara	2X4, 4X4, Petrol, Diesel	86-88	4 Cyl	2.0L, 2.4L	231.086		
Navara	D21 Diesel DI 4WD, RWD	86-98	4 Cyl	2.5L	231.101	320.104	
Navara	D21 RWD	86-95	4 Cyl	2.0L	231.089	320.104	360.029

VEHICLE SENDERS APPLICATION LISTING

NISSAN Continued					Light	Gauge	Gauge
Make/Series	Model	Year	Engine	Capacity	Oil Switch	Temp Sender	Pressure Sender
Navara	D21 Carb 4WD, RWD	86-92	4 Cyl	2.4L	231.089	320.039	360.029
Navara	D22 Diesel RWD, 4WD	97-99	4 Cyl	3.2L	231.089	320.096	
Navara	D22 DIESEL RWD	97-99	4 Cyl	2.7L	231.089	320.096	
Navara	D22 SOHC	97-99	4 Cyl	2.4L	231.089	320.096	360.029
Navara	D21 SOHC 4WD, RWD EFI	92-97	4 Cyl	2.4L	231.089	320.039	360.029
Navara	D21 Diesel DI 4WD, RWD	88-92	4 Cyl	2.5L	231.089	320.039	
Navara	D21 Diesel DI 4WD, RWD	88-97	4 Cyl	2.7L	231.089	320.039	
Navara	D21 SOHC MPFI	92-97	6 Cyl	3.0L	231.089	320.039	
Navara	D22 Series II 4WD, RWD	99-01	4 Cyl	2.4L	231.089	320.096	
Navara	D22 Series II Diesel 4WD, RWD	99-01	4 Cyl	3.2L	231.089	320.096	
Navara	D22	99-01	6 Cyl	3.0L	231.089	320.096	
Navara	D22 Diesel Turbo	01-on	4 Cyl	3.0L	231.089	320.096	
Navara	D22 SOHC	03-06	6 Cyl	3.3L	231.089	320.096	
Nomad	GC22	97-92	4 Cyl	2.4L	231.089		
NX/NX-R	B13	91-95	4 Cyl	2.0L	231.089	320.039	
Pathfinder	Carb	86-92	4 Cyl	2.4L	231.089	320.039	360.029
Pathfinder	D21 Carb 4WD MPFi	92-95	6 Cyl	3.0L	231.089		360.029
Pathfinder	R50 Series I	95-98	6 Cyl	3.3L	231.089	320.096	360.029
Pathfinder	R50 Series II	99-05	6 Cyl	3.3L	231.089	320.096	360.029
Patrol	G60, MQ	65-87	6 Cyl	2.8L, 4.0L	231.086	320.039	
Patrol	G60, MQ, Turbo	80-87	6 Cyl	3.3L	231.086	320.090	
Patrol	GQ OHV Diesel Series I	87-93	6 Cyl	4.2L	231.089		
Patrol	GQ OHV Diesel, Series I, Series II	88-97	6 Cyl	4.2L	231.089		
Patrol	GQ OHC Carb	88-95	6 Cyl	4.2L	231.089		360.029
Patrol	GQ OHC Carb	92-99	6 Cyl	4.2L	231.089		
Patrol	GQ Series II OHV EFI	92-97	6 Cyl	4.2L	231.089	320.039	360.029
Patrol	GQ Series II SOHC Carb	92-97	6 Cyl	3.0L	231.089		
Patrol	GQ Series II SOHC Turbo Diesel	95-97	6 Cyl	2.8L	231.089	320.039	360.029
Patrol	GU OHV Diesel	99-00	6 Cyl	4.2L	231.089		
Patrol	GU SOHC MPFI	97-00	6 Cyl	4.5L	231.089		
Patrol	GU SOHC Turbo Diesel	98-00	6 Cyl	2.8L	231.089	320.096	360.029
Pintara	R31 Sedan RWD	86-90	4 Cyl	2.0L	231.089	320.096	
Pintara	U12 Sedan FWD	89-92	4 Cyl	2.0L	231.089	320.096	
Pintara	U12 SOHC	89-92	4 Cyl	2.4L	231.089		
Prairie	M10 SOHC Carb	82-86	4 Cyl	1.5L	231.084	320.039	
Pulsar	N10	80-81	4 Cyl	1.4L	231.086		
Pulsar	N12, EXA - ET	83-87	4 Cyl	1.5L	231.102		
Silvia	Imported S12 Turbo	84-88	4 Cyl	1.8L	231.089		
Skyline	C210	78-81	6 Cyl	2.4L	231.086		
Stanza	A10	78-83	4 Cyl	1.6L	231.086		
Terrano II	R20, R20 Turbo Diesel	97-00	4 Cyl	2.4L,2.7L	231.089		
Urvan	E20, E23	74-82	4 Cyl	1.6L, 2.0L	231.086		
Urvan	E24, Diesel	87-92	4 Cyl	2.7L	231.086		
X Trail	T30 DOHC	01-03	4 Cyl	2.5L		320.096	

PEUGEOT					Light	Gauge	Gauge
Make/Series	Model	Year	Engine	Capacity	Oil Switch	Temp Sender	Pressure Sender
205	Gti SOHC	87-90	4 Cyl	1.9L	.		
205	S	90-94	4 Cyl	1.6L	231.108		

VEHICLE SENDERS APPLICATION LISTING

PORSCHE					Light	Gauge	Gauge
Make/Series	Model	Year	Engine	Capacity	Oil Switch	Temp Sender	Pressure Sender
924, 924S, 944	+ Turbo	79-89	4 Cyl	2.0L, 2.5L, 2.7L	231.085		
928, 928S		77-85	8 Cyl	4.5L, 4.7L	231.085		

SAAB					Light	Gauge	Gauge
Make/Series	Model	Year	Engine	Capacity	Oil Switch	Temp Sender	Pressure Sender
99		71-73	4 Cyl	1.9L	231.085		
900	EFI	79-88	4 Cyl	2.0L	231.085		

SEAT					Light	Gauge	Gauge
Make/Series	Model	Year	Engine	Capacity	Oil Switch	Temp Sender	Pressure Sender
Cordoba	GLX	95-98	4 Cyl	1.8L	231.130		

SUBARU					Light	Gauge	Gauge
Make/Series	Model	Year	Engine	Capacity	Oil Switch	Temp Sender	Pressure Sender
Brumby		78-94	4 Cyl	1.6L, 1.8L	231.102	320.043	
DL, GL, Leone		76-95	4 Cyl	1.6L, 1.8L	231.102	320.043	
Fiori		89-92	4 Cyl		231.102		
Forester		97-02	4 Cyl	2.0L	231.102	320.067	
Impreza	LX, GX, AWD	93-98	4 Cyl	1.6L, 1.8L	231.102	320.067	
Impreza	GX, RV, RX	00-on	4 Cyl	2.0L	231.102	320.067	
Impreza	WRX, Turbo	94-on	4 Cyl	2.0L	231.102	320.067	
Liberty	All	91-03	4 Cyl	2.0L, 2.2L, 2.5L	231.102	320.067	
Liberty	BC/BD	89-97	4 Cyl	2.2L	231.102	320.067	
Liberty	BD/BF Turbo	92-93	4 Cyl	2.0L	231.102	320.067	
Liberty	BD/BG	96-00	4 Cyl	2.5L	231.102	320.067	
Liberty		98-on	4 Cyl	2.0L	231.102	320.067	
Liberty		98-on	4 Cyl	2.5L	231.102	320.067	
Outback		96-00	4 Cyl	2.5L	231.102	320.067	
Vortex	XT, Turbo	85-89	4 Cyl	1.8L	231.102	320.043	

SUZUKI					Light	Gauge	Gauge
Make/Series	Model	Year	Engine	Capacity	Oil Switch	Temp Sender	Pressure Sender
Sierra	SJ413	84-98	4 Cyl	1.3L	231.089	320.044	
Carry	ST80, ST90	78-85	4 Cyl		231.089	320.068	
Swift	SOHC, GTi, Carb. & EFI, 4WD	84-00	3 Cyl, 4 Cyl	All	231.089	320.044	
Vitara	SOHC, Carb. & EFI	88-98	4 Cyl	1.6L	231.089	320.044	
X90	4X4 EL	96-98	4 Cyl	1.6L	231.089	320.067	

TOYOTA					Light	Gauge	Gauge
Make/Series	Model	Year	Engine	Capacity	Oil Switch	Temp Sender	Pressure Sender
4Runner	YN60, YN63, YN130	84-90	4 Cyl	2.0L, 2.2L	231.089	320.044	
4Runner	RN130R	90-96	4 Cyl	2.4L	231.104	320.044	360.027
4Runner	LN60, LN61, Diesel	84-89	4 Cyl	2.4L, 2.8L	231.084	320.044	
4 Runner	VZN130	90-91	6 Cyl	3.0L			360.027
Camry	SV11, SV20	83-89	4 Cyl	1.8L, 2.0L	231.102	320.044	

VEHICLE SENDERS APPLICATION LISTING

TOYOTA Continued					Light	Gauge	Gauge
Make/Series	Model	Year	Engine	Capacity	Oil Switch	Temp Sender	Pressure Sender
Camry	SV21, SV22	87-91	4 Cyl	2.0L	231.102	320.067	
Camry	SDV10, SXV10	93-98	4 Cyl	2.2L	231.104	320.036	
Camry	SXV20, ACV36R	97-on	4 Cyl	2.2L, 2.4L	231.104		
Camry	VZV20, VZV21	88-93	6 Cyl	2.5L	231.102		
Camry	VDV10, MCV20R, MCV36R	93-on	6 Cyl	3.0L	231.104		
Camry Avensis	ACM20R	01-on	4 Cyl	2.0L, 2.4L	231.104		
Camry Vienta	VZV20, VZV21	88-93	6 Cyl	2.5L	231.102		
Camry Vienta	VDV10R, MCV20R	93-00	6 Cyl	3.0L	231.104		
Celica	RA23, RA28, TA22, TA23	71-77	4 Cyl	1.6L, 2.0L	231.089	320.043	
Celica	RA60R, SA63	81-84	4 Cyl	2.0L	231.089	320.044	
Celica	ST184R	89-94	4 Cyl	2.2L	231.102	320.036	
Celica	ST185R	90-92	4 Cyl	2.0L	231.102	320.044	
Celica	ST204R, SX, ZR	94-99	4 Cyl	2.2L	231.104	320.088	
Celica	ST205, GT	94-94	4 Cyl	2.0L	231.089	320.036	
Corolla	KE10	66-70	4 Cyl	1.1L	231.089	320.043	
Corolla	KE20	70-74	4 Cyl	1.2L	231.102	320.043	
Corolla	KE30, KE35, KE36, KE50	74-78	4 Cyl	1.2L	231.102	320.043	
Corolla	KE38, KE55	78-79	4 Cyl	1.3L	231.102	320.043	
Corolla	KE38, KE55, KE70R	78-85	4 Cyl	1.3L	231.102	320.044	
Corolla	AE71, AE80, AE82, DOHC	78-89	4 Cyl	1.3L, 1.6L	231.102		
Corolla	AE90	89-92	4 Cyl	1.4L	231.089		
Corolla	AE92, Carb	89-92	4 Cyl	1.4L	231.084	320.067	
Corolla	AE92, AE92R, EFI, 4WD	89-94	4 Cyl	1.6L	231.084	320.067	
Corolla	AE93	92-94	4 Cyl	1.8L	231.104	320.088	
Corolla	AE95R, 4WD	88-95	4 Cyl	1.6L	231.084	320.067	
Corolla	AE101R, AE102R, AE102X, AE112	94-01	4 Cyl	1.8L	231.104	320.088	
Corolla	ZZE122R, ZZE123, Sportivo	01-on	4 Cyl	1.8L	231.104		
Corona	RT40, RT72, RT80, RT81	64-74	4 Cyl	1.5L, 1.6L, 1.9L	231.084	320.043	
Corona	MX10, MX13, MX22, MX23, RT104	72-79	4 Cyl	2.0L, 2.3L, 2.6L	231.084	320.043	
Corona	RT104, RT118, XT130	77-83	4 Cyl	2.0L, 2.3L, 2.6L	231.084	320.043	
Corona	RT132	79-82	4 Cyl	2.0L	231.089	320.044	
Corona	RT133	82-83	4 Cyl	2.0L	231.102	320.044	
Cressida	MX73R	84-85	6 Cyl	2.8L	231.084	320.044	
Cressida	MX73R-DOHC	85-88	6 Cyl	2.8L	231.084	320.044	
Cressida	MX83R	90-93	6 Cyl	3.0L	231.084	320.044	
Crown	RS56, MS65, MS83, MS85, MS111	68-80	4Cyl, 6 Cyl	2.0L, 2.8L	231.089	320.043	
Crown	MS112	80-83	6 Cyl	2.8L	231.084	320.044	
Crown	MS123	83-87	6 Cyl	2.8L	231.084	320.044	
Crown	MS125	83-88	6 Cyl	2.8L	231.084	320.044	
Echo	NCP10R, NCP12R, NCP13R	99-on	4 Cyl	1.3L, 1.5L	231.104		
Estima	TCR10W, TCR11W, TCR20W	93-99	4 Cyl	2.4L	231.104	320.036	
Hi-Ace	RH: 10, 11, 15, 16, 20, 30, 32	67-85	4 Cyl	1.5L, 1.6L	231.089	320.043	
Hi-Ace	YH: 50, 51, 53, 60, 61, 63, 71, 73	83-89	4 Cyl	1.8L, 2.0L, 2.2L	231.089	320.044	
Hi-Ace	RZH103, RZH113	89-98	4 Cyl	2.4L	231.104	320.036	
Hi-Ace	RZH103R, RXZH113R, EFI	98-05	4 Cyl	2.4L	231.089	320.036	
Hi-Ace - Diesel	LH: 20, 30, 50, 51, 60, 61, 70, 71	81-89	4 Cyl	2.2L, 2.4L	231.089	320.044	
Hi-Ace - Diesel	LH103R, LH113R, LH125R	89-00	4 Cyl	2.8L	231.084	320.036	
Hi-Ace - Diesel	LHR172R, LHR184R	99-05	4 Cyl	3.0L	231.084	320.036	
Hi-Lux	YN: 55, 56, 57, 58, 65, 67	83-88	4 Cyl	1.6L, 1.8L, 2.0L, 2.2L	231.089	320.044	

VEHICLE SENDERS APPLICATION LISTING

TOYOTA Continued					Light	Gauge	Gauge
Make/Series	Model	Year	Engine	Capacity	Oil Switch	Temp Sender	Pressure Sender
Hi-Lux	YN85R	88-97	4 Cyl	1.8L	231.104		
Hi-Lux	RN85R, RN90R, RN105R	90-92	4 Cyl	2.4L	231.102		
Hi-Lux	RN85R, RN90R, RN105R	88-97	4 Cyl	2.4L	231.104		360.027
Hi-Lux	RN106R, RN110	88-97	4 Cyl	2.4L	231.104	320.036	360.027
Hi-Lux	RZN147R, EFI,	97-05	4 Cyl	2.0L, 2.7L	231.104	320.036	
Hi-Lux	VZN167R, VZN172R	01-05	6 Cyl	3.4L	231.104	320.036	
Hi-Lux - Diesel	All 2.2L engines	78-83	4 Cyl	2.2L	231.089	320.036	
Hi-Lux - Diesel	All 2.4L engines	83-91	4 Cyl	2.4L	231.084	320.044	
Hi-Lux - Diesel	LN86R, LN106R, LN 107R	88-97	4 Cyl	2.8L	231.084	320.044	
Hi-Lux - Diesel	LN147R, LN167R, LN172R	97-05	4 Cyl	3.0L	231.084	320.044	
Kluger	MCU28R	03-on	6 Cyl	3.3L	231.104		
Landcruiser	FJ: 40, 45, 55, FJ60	70-75	6 Cyl	3.9L	231.102	320.043	
Landcruiser	FJ: 40, 45, 55, FJ60	75-84	6 Cyl	4.2L	231.102	320.043	
Landcruiser - Petrol	FJ60	80-84	6 Cyl	4.2L	231.104		360.027
Landcruiser - Diesel	HJ60 Diesel	81	6 Cyl	4.0L	231.104		360.027
Landcruiser - Diesel	BJ70 Diesel	84-90	6 Cyl	3.4L	231.102		360.027
Landcruiser	FJ62	84-90	6 Cyl	4.0L		320.044	360.028
Landcruiser	FJ70,FJ73, FJ80	84-91	6 Cyl	4.0L	231.084	320.044	360.028
Landcruiser	FZJ80R	92-98	6 Cyl	4.5L	231.084	320.036	360.028
Landcruiser	UZJ100R	00-on	8 Cyl	4.7L	231.104	320.088	360.026
Landcruiser	UZJ100	98-07			231.084		360.026
Landcruiser	HZJ75RV	90-91	6 Cyl	4.2L	231.084	320.094	360.028
70 Series							
Landcruiser	HZJ78R, HZJ79R	04-on	6 Cyl	4.2L	231.084	320.094	360.025
78 Series							
Landcruiser	FZJ80, HZJ80, HDJ80	95-98	6 Cyl	4.5L, 4.2L, 4.2LDT	231.084	320.094	
GXL 80 Series							
Landcruiser	FZJ105,	98-07	6 Cyl	4.5L	231.084	320.094	360.026
100 Series							
Landcruiser	HZJ105 Diesel	98-07	6 Cyl	4.2L	231.084	320.094	360.025
100 Series							
Landcruiser	VDJ76R	07-on	8 Cyl	4.5L		320.094	360.026
Turbo Diesel							
Landcruiser	VDJ78R/VDJ79R	07-on	8 Cyl	4.5L	231.104		360.026
Turbo Diesel							
Landcruiser	UZJ200/VDJ200	07-on	8 Cyl	4.7L, 4.5LTD			360.026
Lexen	VN I	89-90	6 Cyl	3.8L	231.088		
Lexen	VN II	90-91	6 Cyl	3.8L	231.088	320.033	
Lexen	VP	91-93	6 Cyl	3.8L	231.088	320.033	
Lexen	VR	93-95	6 Cyl	3.8L	231.088	320.033	
Lexen	VS	95-97	6 Cyl	3.8L	231.088		

VEHICLE SENDERS APPLICATION LISTING

TOYOTA Continued					Light	Gauge	Gauge
Make/Series	Model	Year	Engine	Capacity	Oil Switch	Temp Sender	Pressure Sender
Light Ace	KM20, KM36	80-92	4 Cyl	1.3L, 1.5L	231.102	320.044	
Light Ace	YM21, YM30, YM40, YM41	84-88	4 Cyl	1.8L, 2.0L	231.102	320.044	
Light Ace Diesel	1C engines	83-92	4 Cyl	1.8L	231.084	320.044	
MR2	SW20R	90-94	4 Cyl	2.0L	231.102	320.044	
MR2	SW20R	95-99	4 Cyl	2.0L	231.102	320.036	
MR2	ZZW30R	00-on	4 Cyl	2.0L	231.104		
Paseo	EL44R, EL54R	91-95	4 Cyl	1.5L	231.104	320.067	
Paseo	EL44R, EL54R	95-99	4 Cyl	1.5L	231.104	320.088	
Prado	RZJ95R, RZJ120R	96-04	4 Cyl	2.7L	231.104	320.088	
Prado	VZJ95R, GRJ120R	99-04	6 Cyl	3.4L, 4.0L	231.104		
Prado	KZJ95R, KZJ120R	99-04	6 Cyl	3.4L, 4.0L	231.104	320.088	
Prius	NHW11R, NHW20R	01-on	4 Cyl	1.5L	231.104		
RAV4	SX10R, SXA11R	94-00	4 Cyl	2.0L	231.104	320.036	
RAV4	ACA20R, ACA21R, ACA22R, ACA23R	94-00	4 Cyl	2.0L, 2.4L	231.104		
Soarer	JZZ30, JZZ31	91-00	6 Cyl	2.5L, 3.0L	231.104		
Soarer	UZZ30, UZZ31, UZZ32	91-00	8 Cyl	2.5L, 3.0L, 4.0L	231.104		
Spacia	YR22R	93-98	4 Cyl	2.2L	231.104	320.036	
Spacia	SR40R	98-01	4 Cyl	2.0L	231.104		
Starlet	EP91R	96-99	4 Cyl	1.3L	231.104	320.067	
Tarago	YR20	83-84	4 Cyl	1.8L	231.089	320.044	
Tarago	ACR30R	00-on	4 Cyl	2.4L	231.104	320.036	
Tarago - Diesel	CR21	83-88	4 Cyl	2.0L	231.084	320.044	
Tarago	TCR10R, TCR11R	90-00	4 Cyl	2.4L	231.104	320.036	
Tarago	TCR20R, TCR21R	90-03	4 Cyl	2.4L	231.102	320.044	
Toyo Ace - Diesel	LY30, LY31	82-85	4 Cyl	2.2L, 2.4L	231.089	320.044	

VOLVO							
Make/Series	Model	Year	Engine	Capacity	Oil Switch	Temp Sender	Pressure Sender
240, 242, 244, 245		81-83	4 Cyl	2.3L	231.113		
360, 740	incl.Turbo	84-91	4 Cyl	2.0L, 2.3L	231.113		
850	incl.Turbo	92-97	4 Cyl	2.3L, 2.5L	231.113		
940, 960		90-97	4 Cyl, 6 Cyl	2.3L, 2.5L	231.113		
C70		99-04	5 Cyl	2.3L, 2.5L	231.113		
S40, V40	incl.Turbo	97-04	4 Cyl	1.8L	231.104		
S40, V40	incl.Turbo	97-04	4 Cyl	2.0L	231.113		
S60, S60R		02-04	5 Cyl	2.3L, 2.4L	231.113		
S70, V70	incl.Turbo	97-03	5 Cyl	2.3L, 2.4L	231.113		
S70R	Turbo	03-04	5 Cyl	2.3L	231.113		
S80	TS95, TS97	98-03	6 Cyl	2.9L	231.113		
S90, V90		97-98	6 Cyl	2.9L	231.113		
XC70, XC90		03-on	6 Cyl	2.9L	231.113		

Note: All care has been taken in preparing and compiling this senders' application list, although if errors are detected, please report them by phone (03) 9468 1151 or fax (03) 9468 1502 to VDO, Customer Service department.

ELECTRONIC SWITCH BOXES

ELECTRIC ADJUSTABLE SWITCH BOX



Switch Box 410.060



Switch Box 410.061



Switch Box 660.990



Switch Box 411.101

Designed to be used in conjunction with VDO electric temp or pressure gauges with senders, or can be used using VDO senders only (extra resistor 1K, 1W required).

Ideal for switching warning lams, buzzers, external relays, thermofan and other devices.

Features 5 amp N/O or N/C Relay contact output.

Adjustable Electronic Switch Boxes		12/24V
Part No.	Description	Specification
410.060	Suitable for 1 warning function	2000-10 ohms input 5 amp relay output 1 input - 1 output
410.061	Suitable for 3 separate warning functions	2000-10 ohms input Transistor Output 3 input - 3 output

MULTI-FREQUENCY SWITCH BOX

The VDO RPM and Speed Switch has been designed to work with all standard ignition systems, and will provide a negative output once a predetermined RPM has been reached. In standard format the signal will turn off once the RPM falls below the pre-set point. Dip Switches are provided to pprogram the level of hysteresis, or alternatively latch the relay on. Applications include driving a warning light or buzzer.

RPM Switch		
Part No.	Description	Specification
660.990	12/24V RPM switch	3 amp relay output RPM range 0-12000 rpm
	*Will work off alternator	4/6/8cyl
411.101	12/24V RPM switch	Switch range 2Hz - 9,990 Hz 5 amp relay contact output, 2 channels. Sine & Square wave inputs.

ELECTRONIC RATIO BOX

The VDO Electronic Ratio Box is designed to divide or multiply an input frequency by a fixed ratio. The input signal could be a speedometer or tachometer signal from a magnetic pickup, alternator pickup or Hall effect sender. Typical applications include correcting the speedometer on a vehicle which has had the diff ratio changed, or calibrating a tachometer which has no calibration adjustment.

Suitable for 12/24V applications.

Signal Amplifier/Divider		12/24V
Part No.	Description	Specification
411.105	Electronic Ratio box	Input: Hall effect, 0.7-10V p-p Inductive, 1.5-50V
	Output:	Square wave 0-10V p-p or V supply
	Output:	Triangular wave output



Switch Box 411.105

SIGNAL AMPLIFIER/DIVIDER

The VDO Signal Amplifier/Divider is a general purpose module designed to work with most speedometer and tachometer signals. This box will amplify a low voltage signal to a 10V peak to peak square wave. This can be useful when a signal is too low to drive a speedometer, tacho, cruise control or any other such device. The signal may also be divided in frequency by a factor of 1, 2, 4, 8, or 16 to allow easier integration to another instrument.

Signal Amplifier/Divider		12/24V
Part No.	Description	Specification
411.096	Signal amplifier/divider programmable	Signal input: 2+V p-p 0-10khz Output: 10.0V square wave



Signal Amplifier 411.096

GAUGE OHMS RANGE CONVERSION BOX 12/24V

The 410.063 has been designed to correct the problem that occurs when an original vehicle sender is not available to match a particular gauge and vice versa. Another example is where the level sender in an LPG tank can be used to accurately drive the original (petrol) fuel gauge in a vehicle. Or the unit could be automatically switched to read between petrol and gas.

It can also 'copy' the signal from an existing gauge/sender combination so that the fuel level may also be observed at a different location. In this case, one sender can be used to drive three or four matching gauges. Because the unit is effectively a 'resistance converter' it can also be used on temperature or pressure gauges to correct where the original sender is no longer available for a gauge.

A further advantage is the 8 point conversion curve built in to the unit. This allows it to be used where the resistance graph is a curve, as in large and irregular shaped fuel tanks on trucks and off-road vehicles.

Setting up is extremely simple and can be done on site with almost all applications. Alternately the modules can be pre-programmed if necessary to fit a particular application.

Suitable for 12/24V applications.

Signal Amplifier/Divider		12/24V
Part No.	Description	
410.063	Gauge ohm range conversion box	



Switch Box 410.063

*Converts any resistance range from 0 – 1,000 OHMS or 1,000 – 0 OHMS



DT2236



105.001

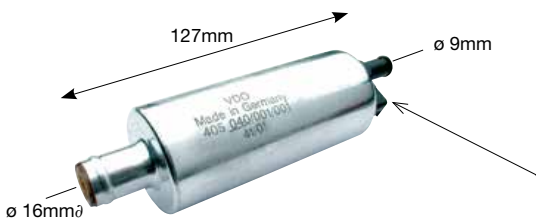

ACCESSORIES

DIGITAL HAND HELD TACHOMETERS

Digital Hand Held Tachometers

Part No.	Description
DT 2236	Digital Hand Held Tacho (Photo/Mech)

Accessories

Part No.	Description
DT 2234 / 36 tape	Reflective tape for phototach

TYRE PRESSURE GAUGE

For the conscientious driver who likes to retain a consistent Tyre pressure. Supplied in a handy leather pouch. Dual scale bar/psi.

Tyre Pressure Gauge

Part No.	Range
150.050	0 - 4.5bar (0 - 64psi)
150.050S	Replacement rubber seal

Speed Alert 12/24V

Part No.	Description	Size
124.130	Speed Alert Kit (Suits electronic speedometers)	70x45x22mm

GAUGE CHECK

Gauge Check Tester

Part No.	Description
105.001	Ohms tester for resistance gauges 2-500 ohms
105.002	Adjustment Pot

OIL PUMP, electrical

Electric Oil pump used to pump engine or gear oil.

Oil pump 12V

Part No.	Description
405040001001	160 Litres per hour

Note: 100°C to 150°C working temperature, 4 bar pressure. Polarity is written on the socket.

HOUSING BINNACLE, plastic

Suitable for BA and BF Ford Falcon in black.

Instrument Housing - Ford Falcon		
Part No.	Description	Suitable For
740.301	2 gauges Binnacle Housing	BA-BF Falcon

Suitable for VY and VZ Commodore in grey.
Not suitable with climate control versions.

Instrument Housing		
Part No.	Description	Suitable For
B06020601P	2 gauges Binnacle Housing	VY-VZ Commodore



HOUSING

Steel mounting cups with smooth black or polished chrome finish.

Instrument Housing		
Part No.	Finish	Suitable For
240.018	Black	85mm instruments with max. installation depth of 80mm



Gauge housing 240.018

Plastic mounting cups with adjustable clip-on pedestal.

Instrument Housing	
Part No.	Suitable For
230.028	52mm Instruments with max. Installation depth of 62mm
230.029	52mm instruments with max. installation depth of 97mm
230.030	80mm instruments with max. installation depth of 90mm



Gauge housing 230.028

Suitable for all 52mm instruments.

Instrument Panels	
Part No.	Configuration
230.005	Single
230.006	Double
230.007	Triple



Single gauge panel 230.005



Twin gauge panel 230.006

BRACKETS, metal black

Suitable for single instrument mounting.

Brackets - Metal Black	
Part No.	Description
230.001	52mm instruments



Bracket 230.001



Spin lock clamp 800.005.015



Stud kit 600.402



Spacer 230.037



Blank 230.038



Reduction ring 230.004

CLAMP RINGS & STUD KITS

Suitable for Vision range of instruments.

Clamp Rings & Stud Kits - Plastic White

Part No.	Description
800.005.015	Spin lock clamp ring for 52mm instruments
800.005.005	Spin lock clamp ring for 80mm instruments
800.005.006	Spin lock clamp ring for 85mm instruments
800.005.007	Spin lock clamp ring for 100mm instruments
600.402	Stud kit for 52mm (not for speedo, tacho & pyrometer)

ANTI-GLARE SPACER

Suitable to align a 52mm panel-mounted instrument at a 15° angle.

Angled Spacer Ring - Plastic Black

Part No.	Description
230.037	Angled instrument adaptor

INSTRUMENT BLANK, plastic black

Suitable for plug a 52mm cut-out.

Clamp Rings & Stud Kits

Part No.	Description
230.038	Instrument blank

REDUCTION RINGS, metal black

Used for mounting 52mm and 80mm instruments in 60mm and 85mm cut-outs.

Reduction Rings

Part No.	Description
230.004	60mm – 52mm

LED GLOBES

Wiring Kits		
Part No.	Voltage	Quantity
240.720	12V	1 only
240.730	12V	Pack of 10



LED Globe 240.720

GLOBE HOLDERS & GLOBES

Globe Holders & Globes		
Part No.	Description	Specification
240.001	BA 7s style J	12V 2W
240.002	BA 7s style J	24V 2W
240.003	BA 9s style H	12V 2W
240.004	BA 9s style H	24V 3W
240.009	W2.0 x 4.6 mini wedge W5	12V 1.2W
240.011	W2.0 x 4.6 mini wedge W5	24V 1.2W
240.712	BA 9s style H insulated	12V 2W
240.713	BA 9s style H insulated	24V 3W
800005002	Vision range globe holder & globe	12V 2W
240.733	7mm 12V wedge red globe	12V 2W
240.734	7mm 24V wedge red globe	24V 2W
800005003	International range globe holder & globe	24V 3W



Globe holder 240.733



Globe holder 800005002

GLOBES

Globes			
Part No.	Description	To Suit	Specification
240.050	Mini wedge globe	240.009/733	12V 1.2W
240.051	Mini wedge globe	240.011/734	24V 1.2W
240.052	Wedge globe	800005002	12V 2W
240.053	Wedge globe	800005003	24V 3W
240.054	Bayonet globe 7mm	240.001/012	12V 2W
240.055	Bayonet globe 7mm	240.002/013	24V 3W
240.056	Bayonet globe 9mm	240.003/712	12V 2W
240.057	Bayonet globe 9mm	240.004/010/713	24V 3W

Note: WWG gauges use light globe Part no. 240.052 (12V 2W) or Part no. 240.053 (12V 3W) Suitable for speedo, tacho or all 52mm gauges



Wedge globe 240.050



Bayonet globe 240.055

LIGHT COVERS

Light Covers		
Part No.	Description	To Suit
240.068	10mm green	240.052/053
240.069	5mm green	240.050/051
240.070	10mm red	240.052/053
240.071	5mm red	240.050/051
240.072	10mm blue	240.052/053
240.073	5mm blue	240.050/051



WIRING KITS

Wiring Kits		
Part No.	Description	Specifications
240.030	3 wire kit - oil - temp - fuel	3mm wire
240.031	2 wire kit - volts - clock	3mm wire
340.824	8 Pin plug kit for speedo's Tachometers / Tachourmeters	Plug + 8 terminals



Wiring Kit 240.030

CONVERSION TABLES

Boiling temperature vs Pressure				Thread Sizes & Turns Per Inch			Pressure Equivalents		
Celsius	Fahrenheit	PSI	lbs	Thread	Size	Diameter	Kpa	PSI	BAR
100	212	14.7	0	NPT	1/8"-27	10.287mm	10	1.45	0.1
101	213.3	15.3	1/2		1/4"-18	13.716mm	50	7.25	0.5
105	221	17.5	3		3/8"-18	17.145mm	100	14.5	1
107	225	19	4		1/2"-14	21.336mm	200	29	2
109	228	20	5	BSP	1/8"-28	9.728mm	350	50.7	3.5
112	233	22	7		1/4"-19	13.157mm	600	86.9	6
119	246	28	13		3/8"-19	16.662mm	850	123	8.5
121	250	30	15		1/2"-14	20.995mm	1750	254	17.5
Note: Approximate values at sea level.				SAE(UNF)	5/8"-18	15.875mm	2500	363	25

TEMP SENDER CALIBRATION CHARTS

Range 40 - 120 Deg. C		Range 50 - 150 Deg. C		Range 60 - 200 Deg. C		Temp Equivalents	
Deg. C	Ohms	Deg. C	Ohms	Deg. C	Ohms	Celsius	Fahrenheit
20	676.9	40	481.5	60	581	-10	14
30	439	60	221.2	80	281.8	5	41
40	291.5	75	128	100	148.8	10	50
50	197.3	82.5	102	115	96	20	68
60	134	87.5	89.3	125	74	30	86
70	97.1	92.5	76.8	135	58.3	40	104
80	70.1	97.5	66	145	46.5	50	122
87	54	102.5	58	155	35.4	75	167
94	45	107.5	50	164	29.2	80	176
100	38.5	115	41	172	24	85	185
107	32.5	125	32.2	180	21.2	90	194
114	28	135	26	188	18	95	203
120	22.4	145	21	196	15.3	100	212
130	17.4	160	15.1	205	12.8	105	221
140	13.8	180	10.2	220	10.1	110	230

PRESSURE SENDER CALIBRATION CHARTS

Range 0 - 2 Bar (200 Kpa)		Range 0 - 5 Bar (500 Kpa)		Range 0 - 10 Bar (1000 Kpa)		Range 0 - 25 Bar (2500 Kpa)	
Bar	Ohms	Bar	Ohms	Bar	Ohms	Bar	Ohms
0	9.63	0	10.65	0	10.241	0	9.9
0.3	37.45	0.75	37.8	1.2	35.4	3	36.7
0.5	55.69	1.25	55.65	2	51.55	5	53.4
0.7	73.7	1.75	73.3	2.8	67.15	7	69.21
0.9	91.4	2.25	90.83	3.5	80.37	9	84.25
1.05	104.53	2.675	105.6	4.1	91.4	10.6	95.75
1.15	113.2	2.875	112.44	4.7	102.1	12.2	106.83
1.25	121.8	3.125	121	5.3	112.52	13.8	117.5
1.35	130.36	3.5	133.77	5.9	122.64	15.4	127.82
1.45	138.85	3.75	142.2	6.5	132.47	17	137.8
1.55	147.3	4	150.62	7.1	142	18.6	147.5
1.65	155.6	4.25	158.97	7.7	151.24	20.2	156.93
1.75	163.9	4.5	167.3	8.4	161.65	21.8	166.14
1.85	172.2	4.75	175.55	9.2	173.04	23.4	175.17
2	184.4	5	183.77	10	183.9	25	184.03

Note: For dual station senders, half the actual resistor value for the same temperature or pressure.

PART NUMBER INDEX

Part Number to Page Index							
Part No.	Page	Part No.	Page	Part No.	Page	Part No.	Page
10121	41	190.888	13	230.006	85	231.085	56
101.264	43	190037002	21	230.007	85	231.086	56
101.265	43	190037003	21	230.008	8, 17, 26, 31	231.087	56
101.266	43	190075004	13	230.012	8, 17, 26, 31	231.088	56
101.267	43	190077006	12	230.013	8, 9, 17, 26,	231.089	56
101.268	43	190077007	12		31	231.091	56
101.269	43	215920102301	64	230.015	8	231.092	56
101.270	43	215950003101	64	230.016	44	231.094	56
101.271	43	215950004301	64	230.017	44	231.096	56
101.350	42	215950004501	64	230.024	8, 17, 26, 31	231.100	56
101.351	42	215992021F	64	230.025	8, 17, 26, 31	231.101	56
101.352	42	220.003	36, 62	230.028	85	231.102	56
101.353	42	220.004	6, 62	230.029	85	231.104	56
105.001	84	220.005	6, 62	230.030	85	231.106	56
105.002	84	220.150-180	62	230.031	61	231.109	56
115910011401	62	220.180-180	62	230.032	61	231.111	56
124.130	84	220.230-180	62	230.033	61	231.112	56
150.050	84	220.250-180	62	230.035	61	231.113	56
150.050S	84	220.260-180	62	230.036	61	231.114	56
150.202	31	220.270-180	62	230.037	86	231.116	56
150.206	31	220.300-180	62	230.038	86	231.121	56
150.316	17	220.320-180	62	230.041	56	231.122	56
150.900	26	220.330-180	62	230.043	23, 56	231.125	56
150035020	17	220.350-180	62	230.044	56	231.129	56
150035022	17	220.600-180	62	230.045	58	231.130	56
150077004	9	220.660-180	62	230.046	58	231.137	56
150077005	9	220.900-180	62	230.050	56	231.140	56
150077010	9	224011000015G	63	230.051	58	231.147	56
150077011	9	224011000018G	63	230.058	44	231.148	56
150077020	8	224011000020G	63	230.059	44	231.150	56
150077026	8	224011000022G	63	230.061	64	231.177	56
150077027	8	224011000024G	63	230.062	64	232.011/017/041	58
151.910	17	224011000026G	63	230.063	64	232011005004D	58
170.701	29	224011000028G	63	230.064	64	232011005017D	58
170.702	4, 24, 29	224011000030G	63	230.065	64	232011005027D	58
170.706	44	224011000034G	63	230.068	17	232011017010D	58
170.708	44	224011000038G	63	230.079	58	232011017016D	58
170.709	44	224011000040G	63	230.080	58	232011017017D	58
170.712	44	224011000045G	63	230.093	58	232011017032D	58
170.713	44	224011000050G	63	230.110NC	58	232011017034D	58
170.714	44	224011000055G	63	230.111NO	58	232011017038D	58
180.059	10, 61	224011000060G	63	230.112NO	58	232011017080D	58
180035002	20	224011000065G	63	230.113NC	58	232011017087D	58
180035004	20	224011000070G	63	230.114NC	58	232011017103D	58
180035005	20	224011000075G	63	230.115NO	58	240.001	87
180035006	20	224011000080G	63	230.115NC	58	240.002	87
180035008	20	2250234	62	230.204	44	240.003	87
180077019	10	22502641141	62	230.205	44	240.004	87
180077020	10	2251016	62	230.990	56	240.009	87
180077021	10	226.900	24	230.993	56	240.011	87
180077022	10	226801015001C	62	231.081	56	240.018	85
180077023	10	230.001	85	231.082	56	240.022	44
190.080	13	230.004	86	231.083	56	240.030	87
190.504	13	230.005	85	231.084	56	240.031	87

PART NUMBER INDEX

Part Number to Page Index

Part No.	Page	Part No.	Page	Part No.	Page	Part No.	Page
240.035	12	310010015	11	320.083	60	331.601	22
240.050	87	310015009	12	320.084	60	331.602	22
240.051	87	310030002	19	320.085	60	331032001	22
240.052	87	310030003	19	320.086	60	331032004	22
240.053	87	310030004	19	320.087	60	331810012004	22
240.054	87	310020001	11	320.088	60	331810012007	22
240.055	87	310020002	11	320.089	60	332.241	31
240.056	87	310035001	20	320.092	11, 19, 28, 60	332.401	35
240.057	87	310040002	19	320.093	28, 32, 60	332.540	35
240.068	87	310040003	19	320.101	61	332.900	26
240.069	87	310040004	19	320.105	61	332020001	12
240.070	87	320.002	28, 32, 60	320.107	60	332010004	12
240.071	87	320.003	60	320.714	12, 19, 32, 35	332030001	21
240.072	87	320.004	28, 32, 60	323801001006K	59	332040001	21
240.073	87	320.006	19, 60	323801001007N	59	333.003	35
240.712	87	320.007	19, 28, 60	323801001008N	59	333.011	23
240.713	87	320.010	11, 19, 28, 60	323801001009N	59	333.012	23
240.720	87	320.011	60	323801001010K	59	333.100	29
240.730	87	320.020	19, 60	323801001040N	59	333.255	29
240.733	12, 87	320.021	11, 19, 28, 60	323801010001D	59	333.900	25
240.734	87	320.022	28, 32, 60	323803001004D	59	333015031	5
240.817C	20	320.024	60	323803001006D	59	333015032	5
260.111	4	320.028	11, 19, 28, 60	323803001008D	59	333015033	5
301.001	6	320.032	60	323803001011D	59	333015034	5
301.002	6	320.033	60	323803001012D	59	333015035	5
301.105	6	320.036	60	323803001013D	59	333015037	5
301.216	30	320.039	60	323803001019D	59	333015038	5
301.401	33	320.041	60	323803004002D	59	333015046	5
301.440	33	320.042	60	323805001001K	59	333015047	5
301.530	36	320.043	60	323805001002C	59	333035002	15
301.550	36	320.044	60	323805001004K	59	333035004	15
301.900	27	320.046	60	323805001005N	59	333035010	15
301.901	28	320.047	60	323805001015N	59	333035011	15
301.902	28	320.050	10, 61	323805003001N	59	333035013	15
301010009	6	320.051	10, 61	323805003002N	59	333035025	15
301010010	6	320.052	10, 61	325805003001C	59	333045002	15
301010011	6	320.053	10, 61	330.100	57	333065001	15
301010015	6	320.054	10, 61	330.102	57	333055002	15
301030001	16	320.055	10, 61	330.102C	57	340.007	63
301030002	16	320.056	10, 61	330.104	57	340.008	63
301040001	16	320.058	61	330.104C	57	340.009	63
301040002	16	320.059	20	330.110	23, 57	340.011	64
310.005	10	320.060	60	330.1100	57	340.013	64
310.006	34	320.062	60	330.1100C	57	340.808	14, 64
310.159	12	320.064	61	330.110C	57	340.824	87
310.239	32	320.065	60	330.115	57	340216001024	64
310.240	32	320.067	60	330.115C	57	340804007019C	63
310.401	34	320.068	60	330.135	57	340808001004G	64
310.520	35	320.072	11, 19, 28	330.135C	57	350.240	30
310.520PK	35	320.074	61	330.160	57	350.401	33
310.701	34	320.075	61	330.160C	57	350.410	33
310.900	25	320.076	61	331.534	23	350.900	27
310.901	35	320.081	60	331.535	23	350.901	27
310010014	11	320.082	60	331.600	22	350010001	8

PART NUMBER INDEX

Part Number to Page Index							
Part No.	Page	Part No.	Page	Part No.	Page	Part No.	Page
350010016	7	360081038008C	8, 18, 54	412.119	49	412.175	49
350010017	7	360081039002C	54	412.120	50	412.176	49
350010021	8	360081039003	54	412.121	50	412.177	49
350020001	7	360081039004C	54	412.122	50	412.178	49
350030005	18	362081001001K	54	412.123	50	412.179	50
350030016	18	362081001002K	54	412.125	50	412.180	50
350030017	18	362081002001K	54	412.126	50	412.181	50
350040011	7	362081003002K	54	412.127	50	412.182	51
350040016	18	362081004001C	54	412.128	51	412.183	51
350040017	18	370.001	13	412.129	51	412.185	51
360.001	33, 55	370.311	13	412.130	51	412.186	51
360.002	7, 18, 55	370.701	13	412.131	51	412.187	51
360.003	55	397015003	20	412.132	51	412.188	51
360.004	33, 55	405040001001	84	412.133	51	412.189	51
360.005	55	410.006	44	412.134	52	412.190	51
360.006	55	410.007	44	412.135	52	412.191	51
360.008	55	410.060	82	412.136	52	412.192	52
360.013	55	410.061	82	412.137	52	412.193	52
360.014	55	410.063	83	412.138	52	412.194	52
360.015	55	411.003	45	412.139	52	412.195	52
360.016	33, 55	411.008	45	412.140	52	412.196	52
360.017	55	411.009	45	412.141	52	412.197	52
360.018	33, 55	411.010	45	412.142	52	412.198	52
360.019	7, 18, 55	411.011	45	412.143	52	412.199	52
360.020	55	411.012	45	412.144	52	412.200	52
360.021	55	411.013	45	412.145	52	412.201	52
360.022	55	411.014	45	412.146	53	412.202	53
360.024	55	411.015	45	412.147	52	412.203	53
360.025	55	411.016	45	412.148	52	412.204	53
360.026	55	411.017	45	412.149	53	412.205	53
360.027	55	411.096	83	412.150	53	412.206	53
360.028	55	411.101	82	412.151	53	412.211	48
360.029	55	411.105	83	412.152	53	412.212	51
360.045	55	412.009	64	412.153	53	412.213	48
360.048	55	412.010	64	412.154	47	412.214	48
360.050	55	412.100	47	412.155	47	412.218	47
360.086	8, 55	412.101	47	412.156	47	412.219	50
360081030001K	54	412.102	47	412.157	47	412.220	50
360081030002K	54	412.103	47	412.158	47	412.222	50
360081030009K	54	412.104	47	412.159	47	412.223	53
360081030010C	54	412.105	47, 83	412.160	47	412.224	52
360081030014C	54	412.106	47	412.161	47	412.225	52
360081030015C	54	412.107	50	412.162	47	412.227	49
360081030017C	54	412.108	48	412.163	47	412.228	49
360081030022C	54	412.109	48	412.164	47	412.229	49
360081030028K	54	412.110	49	412.165	47	412.230	49
360081030039C	54	412.111	49	412.167	48	412.231	49
360081030049K	7, 54	412.112	49	412.168	48	412.232	49
360081032001C	54	412.113	49	412.169	48	412.233	49
360081032002C	54	412.114	49	412.170	48	412.234	47
360081032011C	33, 54	412.115	49	412.171	48	412.235	47
360081032014C	54	412.116	49	412.172	48	412.236	53
360081032025C	33, 54	412.117	49	412.173	48	412.237	48
360081038003C	8, 18, 54	412.118	49	412.174	49	412.238	49

PART NUMBER INDEX

Part Number to Page Index							
Part No.	Page	Part No.	Page	Part No.	Page	Part No.	Page
412.241	48	412.309	47	437015022	4	A2C59514225	38
412.242	48	412.310	47	437015025	4	A2C59514231	37
412.243	48	412.311	48	437015028	4	A2C59514237	37
412.244	53	412.312	48	437015029	4	A2C59514265	39
412.245	53	412.314	48	437015038	4	A2C59514266	39
412.246	48	412.315	48	437025002	4	B06020601P	85
412.247	48	412.316	48	437035016	14	CTA0200KIT	62
412.248	49	412.317	48	437055001	14	CTA0202KIT	63
412.249	49	412.318	48	437055011	14	DT2234/36TAPE	84
412.250	50	412.319	48	600.402	86	DT2236	84
412.251	50	412.320	49	660.990	82	K46004	4, 14, 64
412.252	51	412.321	49	740.301	85	K46020	4, 14, 64
412.253	51	412.322	49	800.005.005	86	K46021	4, 14, 64
412.254	51	412.323	49	800.005.006	86	K70450	64
412.255	51	412.324	49	800.005.007	86	K70451	64
412.256	51	412.325	49	800.005.015	86	K70452	64
412.257	51	412.326	49	800005002	20, 87	K70453	64
412.258	52	412.327	50	800005003	87	K72103	64
412.259	52	412.328	50	880.003	41	K72113	64
412.260	52	412.329	50	880.004	41	N05801432	6, 16, 28, 62
412.261	53	412.330	50	880.012	41	X10232001001	58
412.262	51	412.331	50	880.020	41	X10232001002	58
412.263	48	412.332	50	880.700	41	X10232001003	58
412.264	48	412.333	50	880.770	41	X10232001004	58
412.265	48	412.334	50	900.550	41	X10232001006	58
412.266	50	412.335	50	900.705	41	X10232001007	58
412.267	50	412.336	51	A2C59501781	38	X10232001008	58
412.269	49	412.337	51	A2C59501782	38	X10232001009	58
412.270	49	412.338	51	A2C59510165	62	X10232001010	58
412.271	47	412.339	51	A2C59510171	62	X10397106825	46
412.272	52	412.340	51	A2C59512332	37	X10732002001	40
412.273	52	412.341	51	A2C59512333	37	X10732002002	40
412.277	53	412.342	51	A2C59512391	37	X10732002003	40
412.279	53	412.343	51	A2C59512394	37	X10732002004	40
412.280	53	412.344	51	A2C59512397	37	X39397106152	46
412.284	49	412.345	51	A2C59512399	37		
412.285	53	412.346	52	A2C59512458	39		
412.286	53	412.347	52	A2C59512459	39		
412.287	52	412.348	52	A2C59512545	39		
412.288	50	412.349	52	A2C59512546	39		
412.292	51	412.355	49	A2C59513091	33		
412.295	48	412.358	52	A2C59514082	39		
412.296	50	430.102	57	A2C59514088	39		
412.298	48	430.104	57	A2C59514111	38		
412.299	52	430.110	57	A2C59514123	38		
412.300	49	430.1100	57	A2C59514136	38		
412.301	50	430.115	57	A2C59514149	38		
412.302	50	430.135	57	A2C59514160	37		
412.303	47	430.160	57	A2C59514170	37		
412.304	47	437.100	29	A2C59514182	39		
412.305	47	437.202	29	A2C59514184	39		
412.306	47	437.900	24	A2C59514199	38		
412.307	47	437015007	4	A2C59514206	38		
412.308	47	437015021	4	A2C59514211	38		

VDO Automotive Warranty Policy

Continental Pty Ltd (VDO) warrants the goods against defects in factory workmanship and materials within the warranty period.

The warranty period for automotive, commercial and marine products shall be 24 months from the date of invoice, subject to the usage limitation of 100,000 Km for goods installed in commercial vehicles.

The warranty period for audio and navigation products shall be 24 months from date of invoice.

The warranty period for repaired items shall be 90 days from the date of invoice.

The customer must notify the point of purchase / distributor of any defect coming within the provisions of this warranty within 30 days of the fault occurring.

A copy of the relevant invoice or the relevant invoice number as proof of the date of purchase must be provided with returned goods.

Continental P/L (VDO) liability with respect to this warranty shall be limited at the option of Continental P/L (VDO) to repair or replacement of the goods.

Removal and refitting costs and all freight costs associated with the warranty claims are the responsibility of the customer.

This warranty shall not apply to goods which have been opened by a third party.

Contaminated by oil, water or grease, fitted in excessive vibration environments or improperly connected.

Glass and capillary breakages are excluded from the provisions of this warranty.

Save and except for the express warranty set out above and to the maximum extent permitted by law, all conditions and warranties which may at the time be implied by common law, Trade Practices Act, Fair Trading Act, Goods Act or any other state or Federal Act are excluded.

To the extent that these cannot be excluded and where the law permits.

Continental's liability in respect of any such condition or warranty, shall be limited at the option of Continental P/L (VDO) to repair or replacement of the goods or the supply of equivalent goods or the payment of the costs of the replacing or repairing the goods, or having them replaced or repaired.

Continental Pty Ltd.

2 Scholar Drive

Bundoora Victoria 3083 Australia

Tel: 03 9468 1151

Fax: 03 9468 1502

Email: info@vdo.net.au

www.vdo.net.au

VDO - A Trademark of the Continental Corporation



The information provided in this brochure contains only general descriptions or performance characteristics, which do not always apply as described in case of actual use or which may change as a result of further development of the products. This information is merely a technical description of the product. This information is not meant or intended to be a special guarantee for a particular quality or a particular durability. An obligation to provide the respective characteristics shall only exist if expressly agreed in the terms of contract. We reserve the right to make changes in availability as well as technical changes without prior notice.

VDO