

# KIMAX 1



## **Installations- and Instruction Manual**

## Table of contents

How does it work? .....	3
Air sensor installation.....	5
Hydraulic installation on forklift .....	8
Electrical installation .....	9
Alarms .....	11
Configuration .....	12
Calibration.....	14
Protecting your calibration and configuration.....	16
Daily use .....	17
Serial output.....	19
Troubleshooting .....	20
Dimensions and technical specifications.....	21

### Warranty

Kimax 1 cabin, trailer and hydraulic are all covered by Sense-Tech Weighing Systems ApS guarantee. Electronic failure and broken components caused by normal use are repaired or exchanged when necessary, when sent to the factory.

Damage to your vehicle caused by installation of Kimax instruments or loss of time caused by recalibration or repairs of Kimax instruments are not covered by Sense-tech Weighing Systems ApS in any case.

### Basic safety rules:

Before you start the installation procedure, make sure that the instrument have not suffered any damage during transport.

**Note that the Kimax 1 instruments must be installed and connected in accordance with the regulations valid for the vehicle and country in question.**

**The Kimax 1 instrument must be protected from gravel, water spray from wheels and other factors that may damage the instruments.**

**We recommend mounting the instrument in a position where it is protected from water jets and rinse water.**

Once you have decided where the instrument is to be mounted in the cabin, you have to consider the cable routing.

Special attention should be given to potential damaging factors such as hinging points for tilting the cab.

Once you have decided where the instrument is to be mounted on the chassis, you have to consider the cable routing. Special attention should be given to tensile forces, cuts and other factors that may damage the cables and hoses.

#### Connection of compressed air.

**Before you carry out any installation work related to the air suspension, make sure that the suspension has been brought to the lowest possible position.**

#### Electrical connection

**Always disconnect the battery before you perform any installation work on the system of the vehicle.**

## How does it work?

The Kimax 1 on board scale is an axle pressure gauge that uses pressure gauging on the air suspension to indicate the load, and to keep you informed at all times about the present load situation.

A mechanical system on the vehicle maintains a fixed level of the chassis height through a level valve which adds or subtracts compressed air to the bellows according to the actual load on the vehicle.

Top of bellows, shock absorber and level valve are fixed on the chassis of the vehicle.

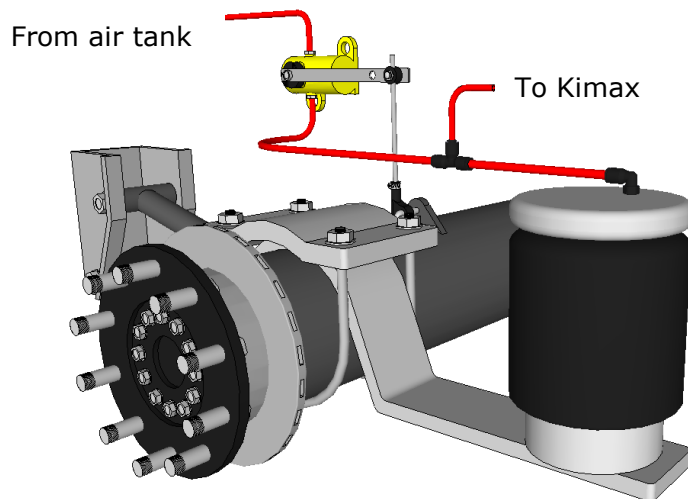

The pressure in the suspension system and in the bellows represents the weight of the vehicle.

The weight of the vehicle is a linear function of the pressure in the suspension system, observe the diagram below.

The Kimax 1 instrument is customized to your vehicle by means of giving in the actual unloaded weight in tons when the truck is empty, and giving in actual loaded weight in tons when the truck is loaded.



**Both values one for an empty vehicle (LO) and one for a loaded vehicle (HI) MUST be entered into the Kimax unit when the pressure in the air suspension is present!**

System accuracy is affected by the mechanical condition of your vehicle, e.g. the condition of the shock absorbers.

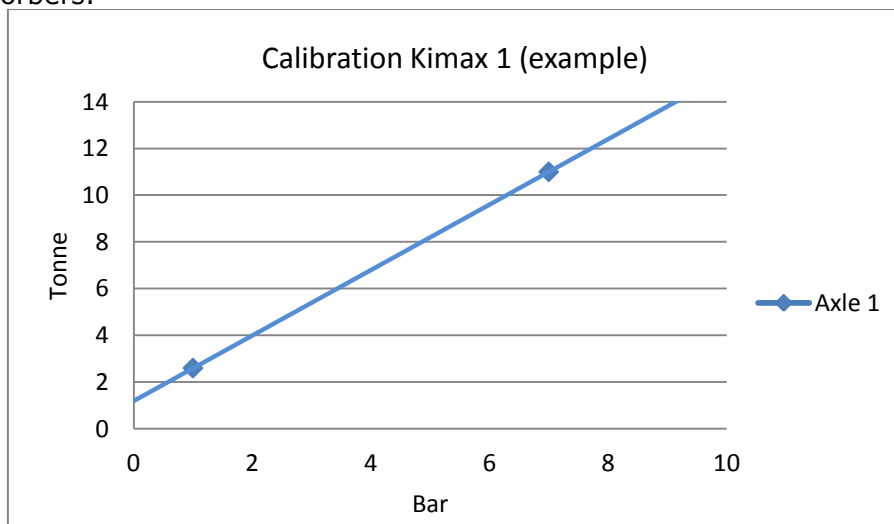

## Basic Kimax 1 installation

Single air inlet is used on vehicles with combined level control for one or more axles.

In case of uneven load from one side to the other the pressure will slowly be equalized between the bellows.

The reading on the Kimax unit will be correct when the pressure is equalized.

This application is ideal for measuring the axle load of one rear axle.

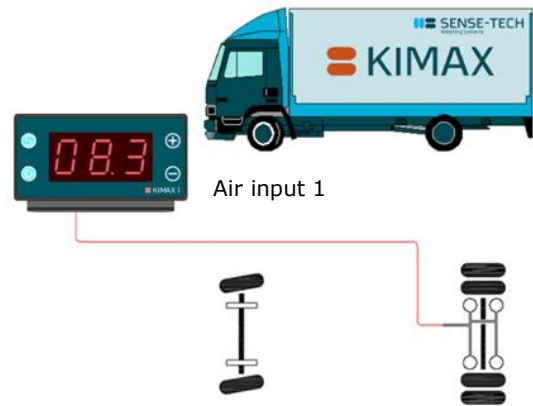

Dual air inlet is used either on vehicles with split level control for one or more axles..

The Kimax unit does the calculation of the air pressure not being equal from one side to the other in case of uneven load.

The reading on the Kimax unit will be correct immediately after loading.

This application is ideal for measuring the axle load of one rear axle.

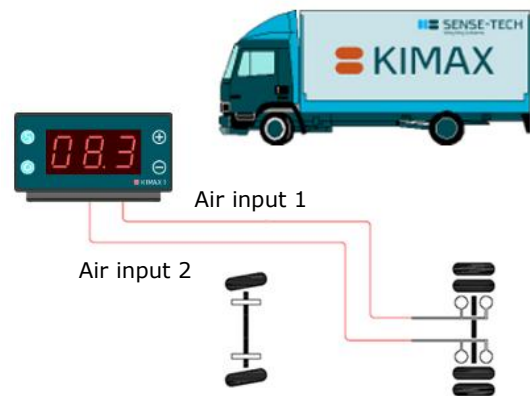

Dual air connection can be applied on vehicles with one or more individual axles arranged in a combined level control system.

Using Kimax 1 on two or more individual axles offers you a limited accuracy, because the measuring of the load depends on the center of gravity for the entire load - for better accuracy we recommend the Kimax 2 for multiple axle purpose.

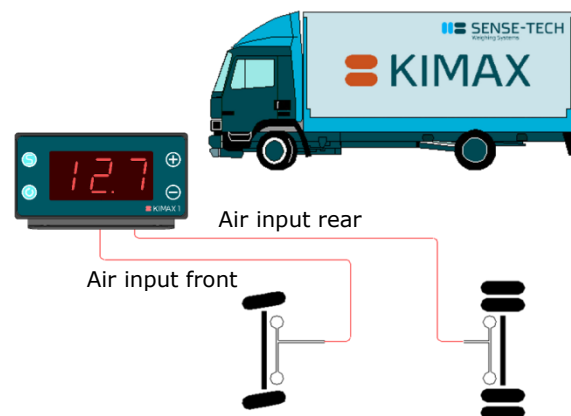

For more information please visit:

[www.kimax.com](http://www.kimax.com)

## Air sensor installation

### Connection of compressed air

Before you carry out any installation work related to the air suspension, make sure that the suspension has been brought to the lowest possible position and all compressed air is released.

First step in the installation is to identify the hose supplying compressed air to the bellows. This hose, typically 8 mm outer diameter, has to be cut through and assembled once again with the T-piece supplied with the Kimax instrument.

The 6 mm output port of the T-piece has to be connected to the Kimax instrument according to the drawing on the next page.

It is important to install the hoses in such a way that they are not affected by other components. The hoses must be fixed at suitable intervals

Route the hoses in such a way that they are not exposed to exhaust heat and other heating sources that may lead to the permissible temperature being exceeded.

Avoid damages from gravel, friction and contact with sharp edges.

Avoid excessive tension of the hoses.

Make sure that the smallest bending radius is not exceeded.

Make sure there is no leakage at the fittings, it will affect the accuracy of the measurement.

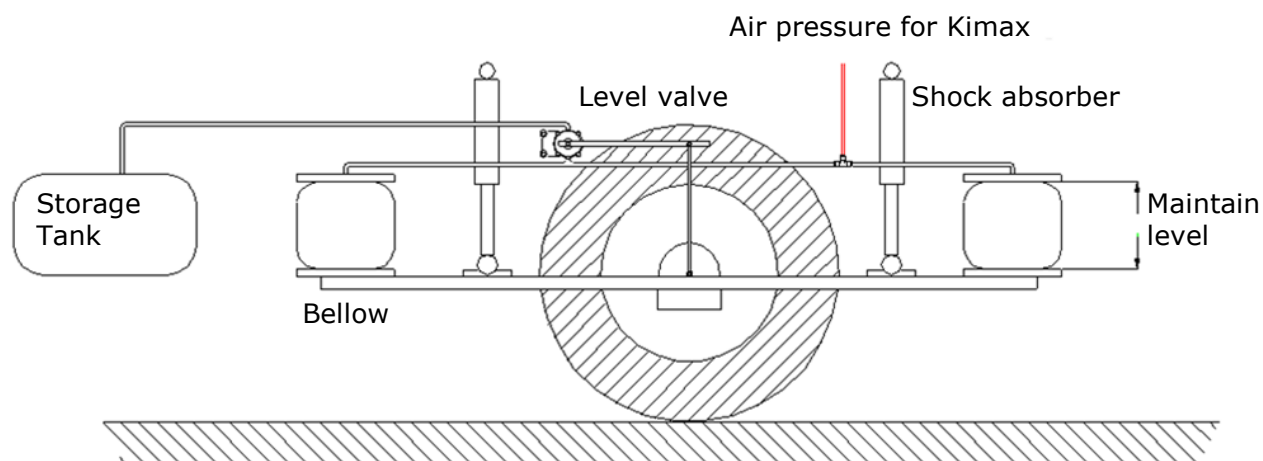

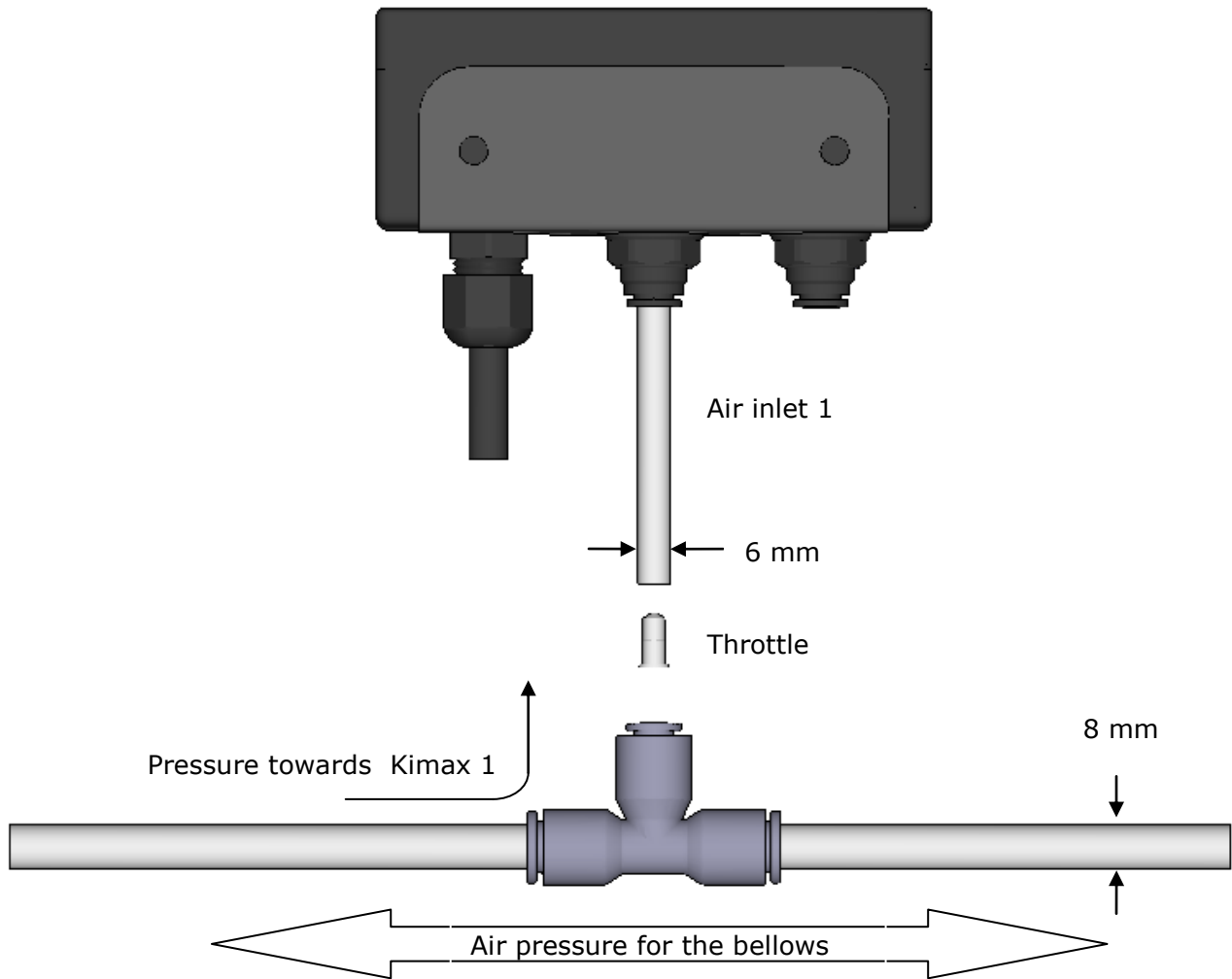

All air-inlets on Kimax instruments and all fittings are quick-release type.

You need to make a clean cut in a right angle with a sharp knife before you connect a new tube to a Kimax instrument.

You can release the locking mechanism by pushing the release ring on the air-inlet. (A 7 mm open-ended spanner is a suitable tool for pushing-in the release ring while you slightly pull out the tube).

## Sensor layout on different vehicles

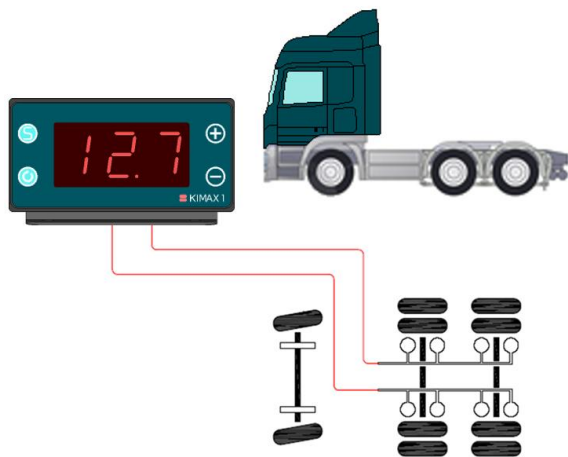
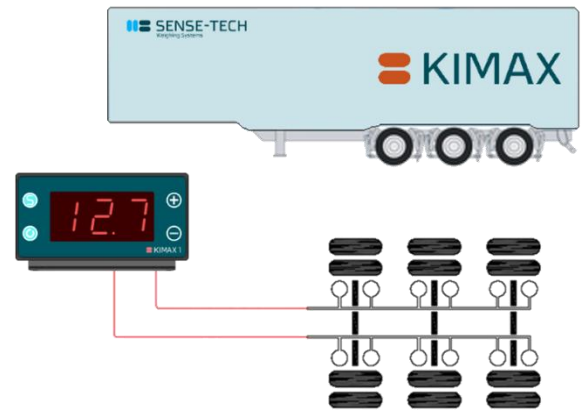
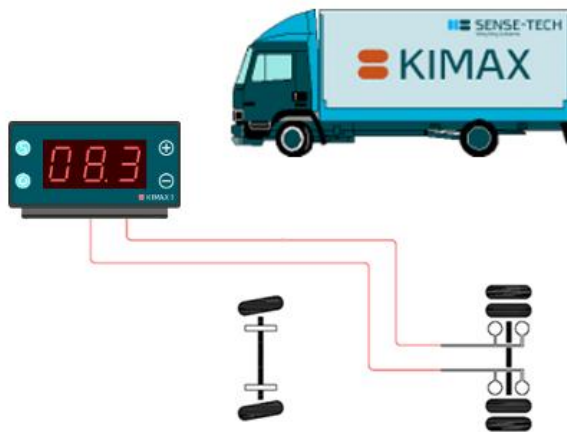
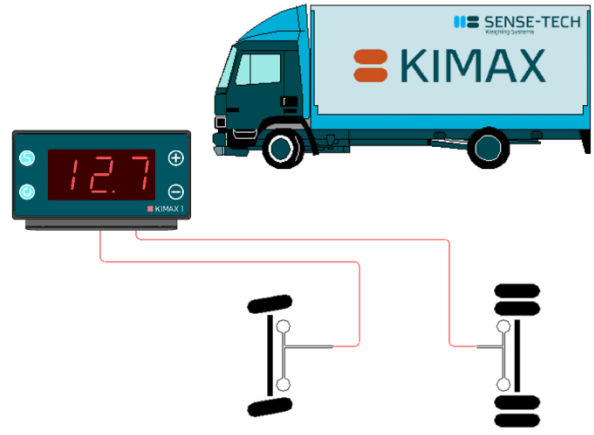
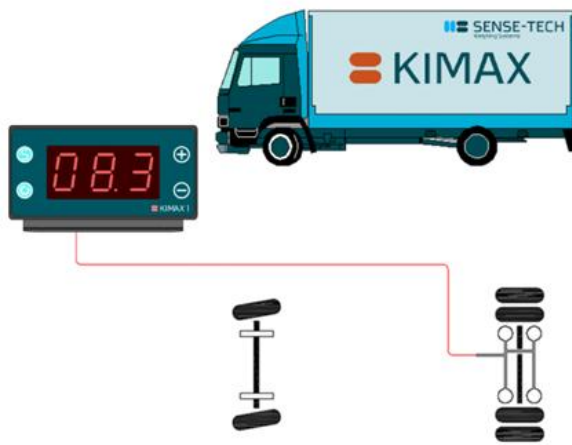

## Hydraulic installation on forklift

The hydraulic sensor is connected as indicated on this diagram.

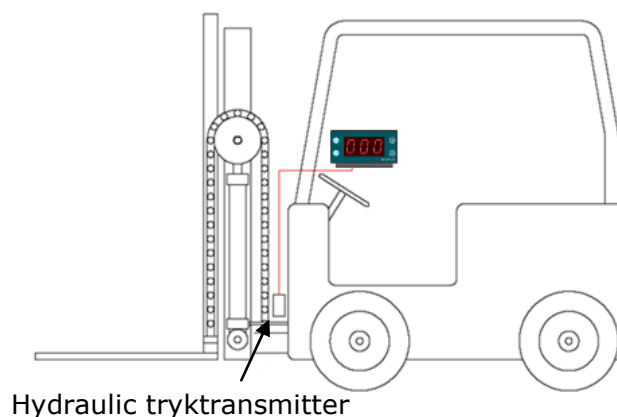
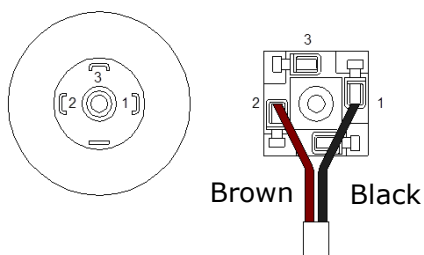

The hydraulic transmitter should be placed as close to the lifting cylinder as possible to obtain the best measuring accuracy.

### Setting the LO calibration point (Kimax 1 Hydraulic)

Raise the forks approx. 20 cm from the ground and lower them again approx. 5 cm.

Enter the menu on the Kimax by pressing for approx. 5 secs (see page 15). Release the button and the display reads **LO**.

Press again and the display reads the last saved value for LO.

This value can be changed by pressing and , until you reach the value that equals the readout you want when the pressure in the lift cylinder is like the present pressure.  
Example 000.

You save the value by pressing now the display reads **HI**.

If you want to maintain the previous value press , now the display reads **HI** and the previous value has not been modified.

### Setting the HI calibration point (Kimax 1 Hydraulic)

Raise the forks approx. 20 cm from the ground with a known weight (the best calibration is obtained if the weight is close to the maximum lift capacity) and lower approx. 5 cm again.

Press and now the display reads the last saved value for **HI**.

You change the value by pressing and until you reach the value that equals the weight of the load.

You save the value by pressing now the display reads **A1**.

If you want to maintain the previous value press , now the display reads **A1** and the previous value has not been modified.

During calibration you can modify **LO** and **HI** in a sequence as described above or you can modify **LO** or **HI** individually by bypassing the value you do not want to change by pressing (see page 15).

During calibration you cannot give in **LO** values higher than **HI** and you cannot give in **HI** values lower than **LO**. (see page 20).



## Electrical installation

### Electrical connection

Always disconnect the battery before you perform any installation work on the system of the vehicle.

Do not route the cables next to ignition cables or other cables carrying large currents.

Make sure that the cables are not exposed to tensile or shearing forces.

Protect the cables with rubber grommet if you route the cables through holes.

For connecting cables use crimp connectors or another approved method.

Avoid short-circuiting the system by faulty connections or squeezed cables.

Fasten the cables at suitable intervals.

Make sure all Kimax 1 instruments are protected by use of fuses in supply cables.

### Basic cabling

Standard versions of Kimax 1 are supplied through a 4 x 0,75 mm<sup>2</sup> cable.

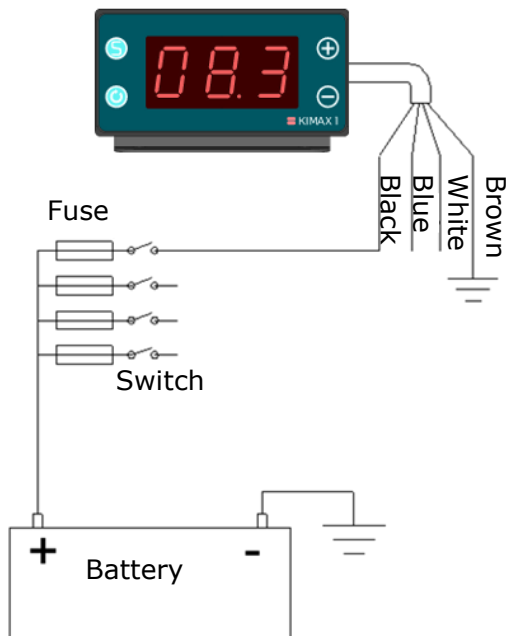

### Cabling with A2 alarm output

Standard versions of Kimax 1 offer you an alarm switch through blue and white wire.

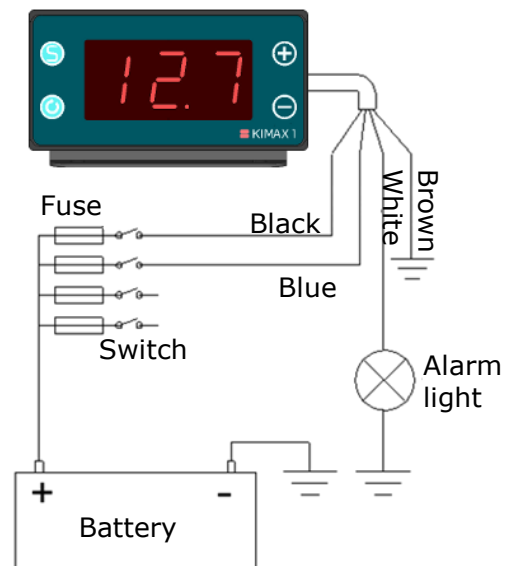

Max current for the relay is 0,5 ampere.

## Optional cabling with printer and alarm

Optional versions of Kimax 1 are supplied through a 5 x 0,34 mm<sup>2</sup> cable.

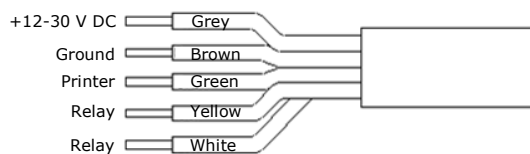
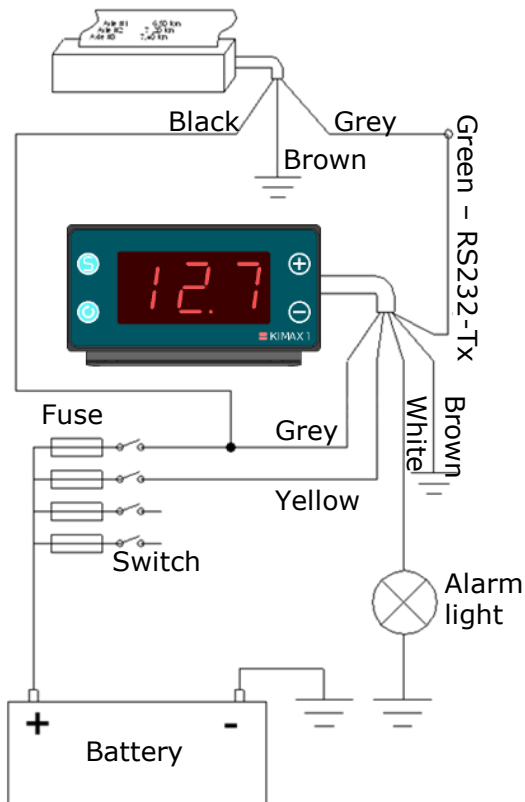

## Cabling with all optional outputs

Optional versions of Kimax 1 offer you an alarm switch through blue and white wire, RS-232 output through green wire and 0-5 V analog through yellow wire.

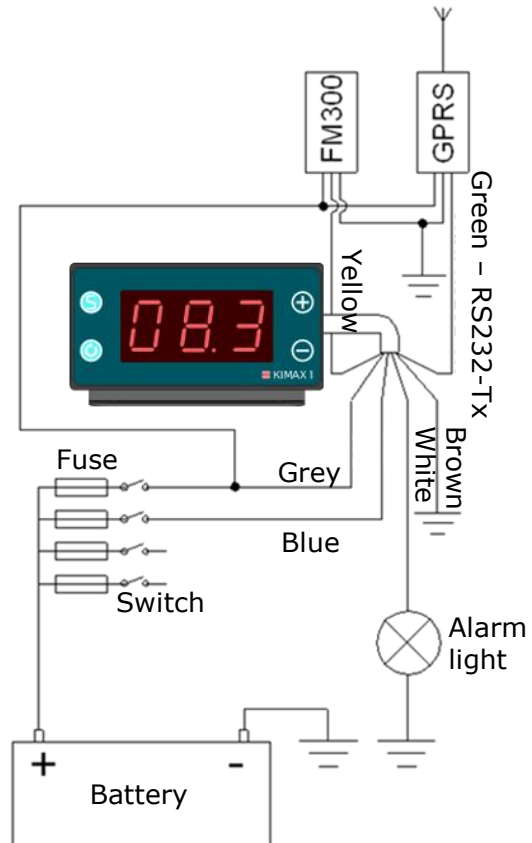

## Alarms

Kimax 1 has two different alarm functions.

When you exceed the A1 alarm level, the three digits in the display start flashing.

When you exceed the A2 alarm level, a relay internal in the Kimax 1 switches on.

The A2 switch function is available for external use through separate wires in the supply cable (see page 10).

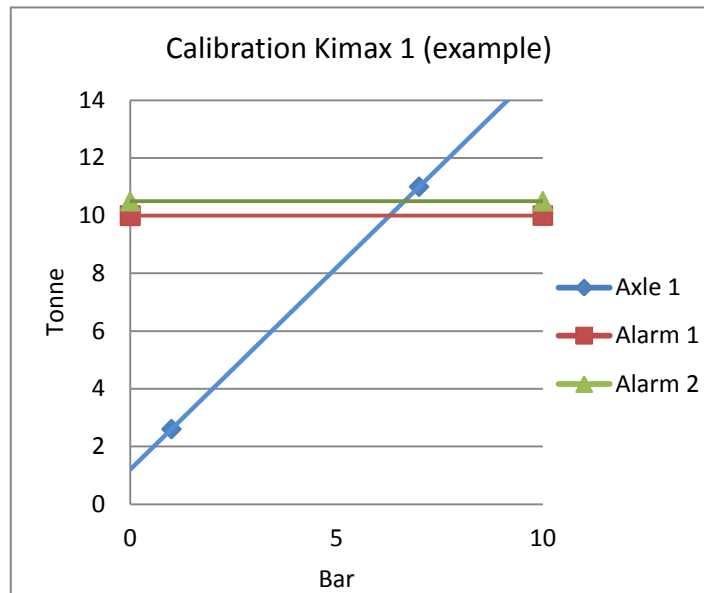

### Setting the A1 alarm level

Enter the Kimax menu by pressing button for 5 sec. (see page 15).

Press button shortly 4 times until the display reads **A1**.

Press button once again shortly, and the display reads the last saved **A1** value.

You can change the readout by and keys until you get a value equal to the alarm level you want.

You save the value by pressing button, and the display reads **A2**.

In the case you want to maintain the previous value, press and the display reads **A2** without saving the modified **A1** value.

You can leave the menu by pressing shortly several times until you read 3 digits on the display or restart the Kimax.

### Setting the A2 alarm level

Enter the Kimax menu by pressing button for 5 sec. (see page 15).

Press button shortly 6 times until the display reads **A2**.

Press button once again shortly, and the display reads the last saved **A2** value.

You can change the readout by and keys until you get a value equal to the alarm level you want.

You save the value by pressing button, and the display reads **OP** or **AA** depending on software version.

In the case you want to maintain the previous value, press and the display reads **OP** or **AA** without saving the modified **A2** value.

You can leave the menu by pressing shortly several times until you read 3 digits on the display or restart the Kimax.

## Configuration

Kimax 1 offers you different configuration settings.

In the **AA** menu you have the option to set the value which equals the 5 volt analog output, this function is only available in units with software version 2.

In the **OP** menu you have the possibility to change the position of the decimal point in the display. Valid positions are: XXX - XX.X - X.XX

In the **OU** menu you have the possibility to change the readout on the display from Tonne (H) to Pound (L) or the other way around provided that the calibration is done correct according to the setting.

In the **US** menu you select the 3-digit LED display to auto off 2 minutes after last  keystroke or set the display to be instant on all the time (factory setting for all units).

### Setting the AA analog level (Software version 2)

Enter the Kimax menu by pressing  for approx. 5 sec. (see page 15).

Press  several times until the display reads **AA**.

Press  once again and the display reads the last saved **AA** value that equals 5 volt analog out.

You can change the value by pressing  or  until the desired value is reached (lowest possible value is 10.0).

Example: You want to have 5 Volt out when the reading equals 11.0 the **AA** setting is 11.0.

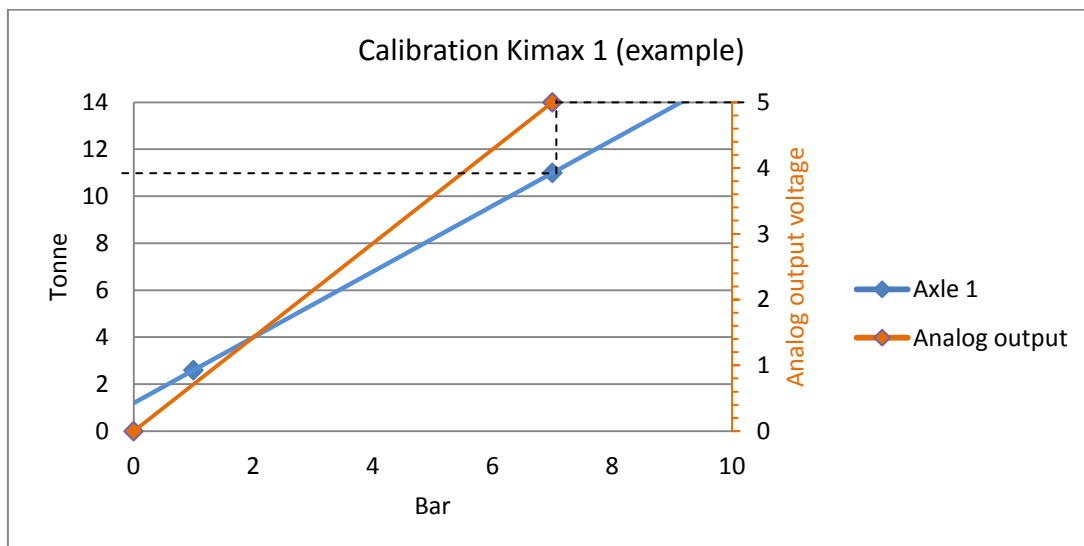

You save the value by pressing  button, and the display reads **OP**.

In case you want to maintain the previous value press , and the display reads **OP**.

You can leave the menu by pressing  several times until the display reads 3 digits or restart the Kimax.

### Setting the decimal position (OP)

Enter the Kimax menu by pressing  button for approx. 5 sec. (see page 15).

Press  button shortly several times until the display reads **OP**.

Press  button once again shortly, and the display reads the last saved **OP** position.

You can change the readout by  and  keys until you get the position you want. Valid positions are: XXX - XX.X - X.XX

You save the value by pressing  button, and the display reads **US**.

In the case you want to maintain the previous setting, press  and the display reads **US** without saving the modified **OP** setting.



You can leave the menu by pressing  shortly several times until you read 3 digits on the display or restart the Kimax.

### Tonne or Pounds setting OU (Software Version 3)

Enter the Kimax menu by pressing  for approx. 5 sec (see page 15).

Press  several times until the display reads **OU**.

Press  again, now the display reads the last saved setting.

You change the setting by pressing  or .

H = Increases the readout on the display with a factor 2,2 (conversion from Tonne to Pounds), if L was the previous setting.

L = Decreases the readout on the display with a factor 2,2 (conversion from Pounds to Tonne), if H was the previous setting.

If you want to maintain the previous setting press  now the display reads **US**.



You can leave the menu by pressing  several times until the display reads 3 digits or restart the Kimax.

### Setting up the display behavior (US)

Enter the Kimax menu by pressing  button for approx. 5 sec. (see page 15).

Press  button shortly several times until the display reads **US**.

Press  button once again shortly, and the display reads the last saved **US** setting.

You can change the readout by  and  keys until you get the setting you want. Valid settings are:

000 = auto OFF,  button switches the display on again.

111 = instant ON.

You save the value by pressing  button, and the display leaves menu.

In the case you want to maintain the previous value, press  and the display leaves menu without saving the modified **US** value or restart the Kimax.

## Calibration



Two reference values are needed in order to make a correct calibration, viz. one value for unloaded vehicle **LO**, and one for loaded vehicle **HI**. By means of these two reference values the Kimax 1 Axle Load Indicator will generate a complete axle pressure curve and display the present axle load in the display.

### Setting the LO calibration point

Go to a weighing bridge with your empty vehicle.

Enter the calibration menu by pressing  for approx. 5 secs (see page 15). The display reads **LO**.

Press  again, now the display reads the last saved value for **LO**.

This value can be changed by pressing  and , until you have the value that equals the readout from the weighing bridge.



You save the value by pressing  and now the display reads **HI**.

In case you want to maintain the previous value, press , the readout is now **HI** and the previous value has not been modified.

### Setting the HI calibration point

Go to a weighing bridge with your loaded vehicle.

Press , and the display reads the last saved value for **HI**.

You can change the value by pressing  and , until you have the value that equals the readout from the weighing bridge.

You save the value by pressing  and now the display reads **A1**.

In case you want to maintain the previous value press , the readout is now **A1** and the previous value has not been modified.

During calibration you can modify **LO** and **HI** in a sequence as described above or you can modify **LO** or **HI** individually by bypassing the value you do not want to change by pressing  (see page 15).

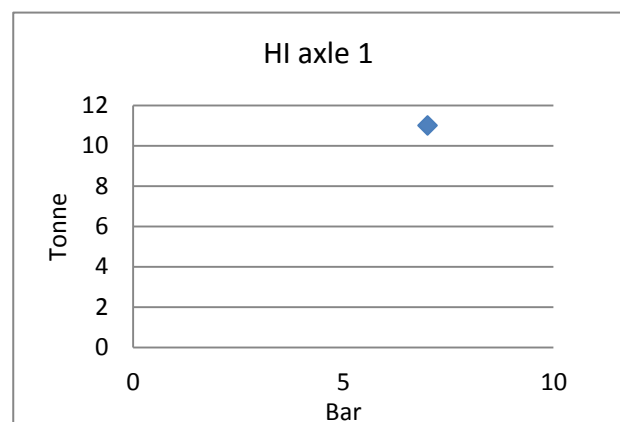
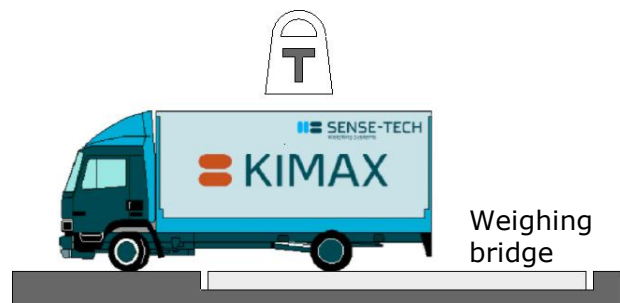
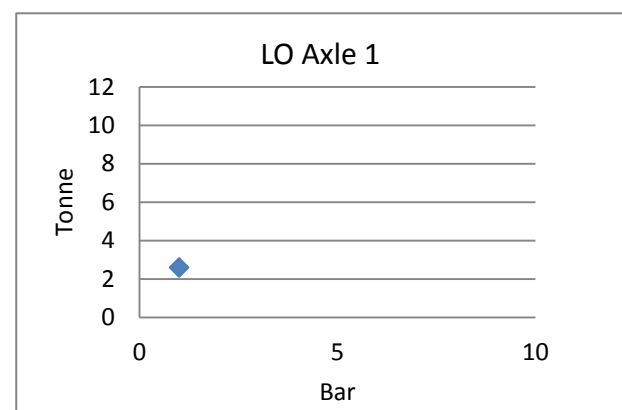
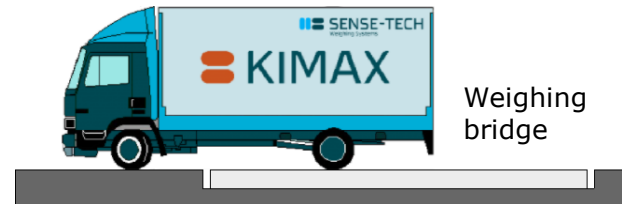

During calibration you cannot give in **LO** values higher than **HI** and you cannot give in **HI** values lower than **LO**. (see page 20).

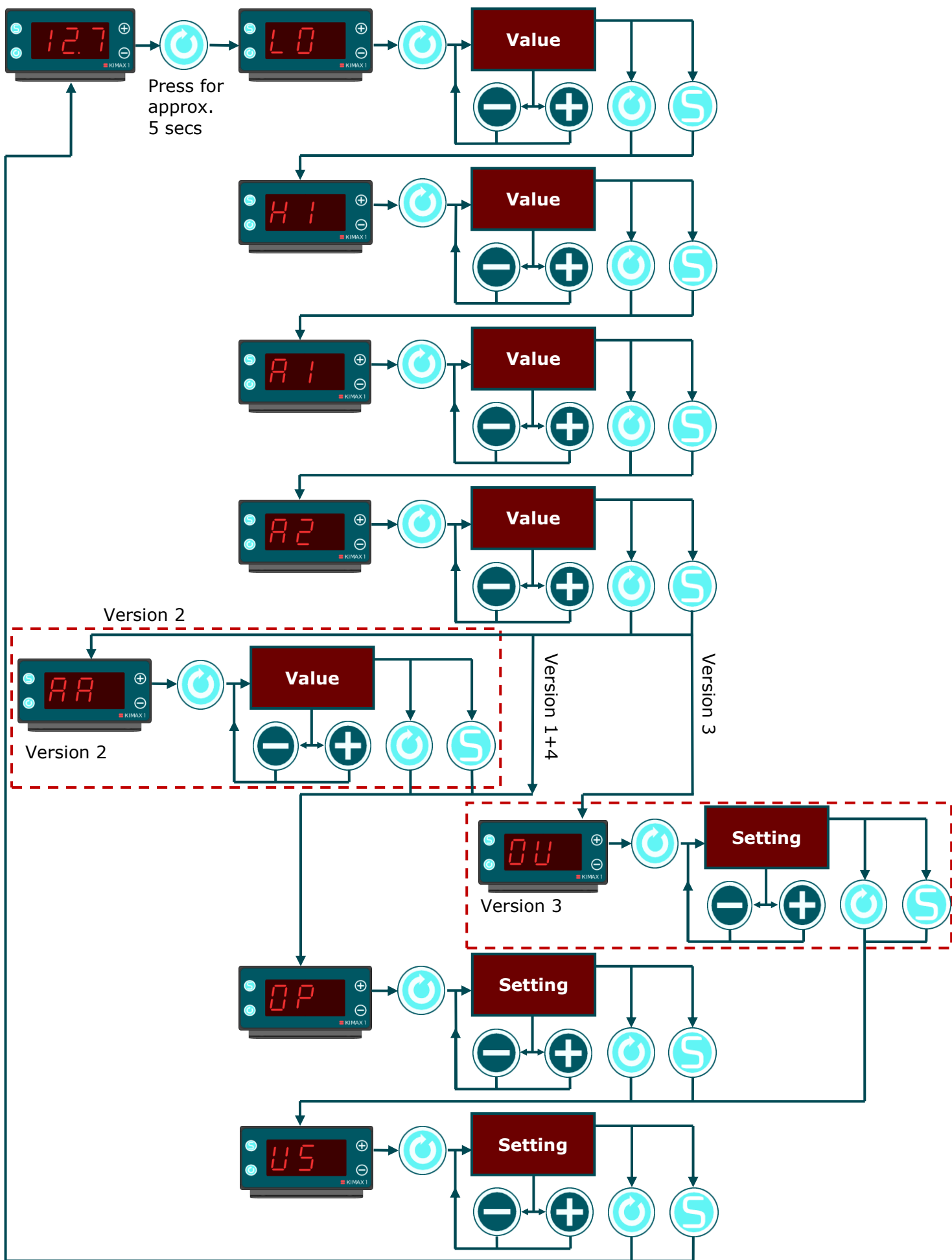





## Protecting your calibration and configuration



### Locking your Kimax 1

To lock your Kimax 1 and hereby prevent unintended change in calibration, - activate  and  at the same time, when the Kimax is powered up and after approx. 5 sec. the display turns off. You may release the buttons, the Kimax reads **LO** and it is locked.



### Checking your software lock

Press either  or  if the Kimax reads "--.-" the unit is locked, if the reading does not change the unit is unlocked. Please repeat the previous description to lock the unit.

### Unlocking your Kimax 1

Before powering up the Kimax activate ,  and  at the same time. After approx. 5 secs the Kimax reads a number between 1-4. Now the Kimax is unlocked and you may release the buttons and choose the software version you want.

If you want to keep you previous calibration you must restart the Kimax now.

You can select any other software version by pressing  and .

When you made your choice you must save it by pressing .

### Changing software version



**If you change the software version, the memory in the instrument will be reset and you have to recalibrate the instrument.**

Software Version	Printer	OBC	5V analog	Variable relay function (3,5)*	Decimal position	Supply cable
Version 1					•	4-wire
Version 2		•	•		•	6-wire
Version 3				•		4-wire
Version 4	•				•	5-wire

- \* 1: Relay output switches on 3,5 Tonne before the set value and switches off again. This pattern continues until the value is 2,7 Tonne from the set value. ON and OFF time is approx. 2%/98%
- 2: From 2,6 to 1,8 from the set value ON and OFF time will be approx. 23%/77%
- 3: From 1,7 to 0,9 from the set value ON and OFF time will be approx. 50%/50%
- 4: From 0,8 to the set value is reached the ON and OFF timewill be approx. 87%/13%

Variable relay-function (3,5)	Interval A2 minus	Interval A2 minus	ON time	OFF time
1. interval	3,5	2,7	0,015 sec (2%)	0,92 sec (98%)
2. interval	2,6	1,8	0,22 sec (23%)	0,72 sec (77%)
3. interval	1,7	0,9	0,46 sec (49%)	0,48 sec (51%)
4. interval	0,8	A2	0,82 sec (87%)	0,12 sec (13%)

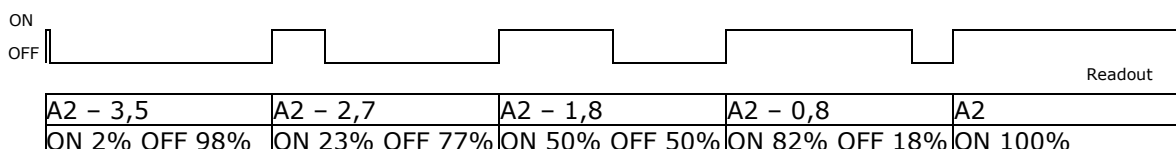



## Daily use

Basically you get Kimax 1 instruments in two different models.

A cabin version intended for mounting inside the cabin of your vehicle.



A trailer version intended for mounting outside on the chassis of your vehicle. The trailer version is splash-water proof and is designed to withstand the environmental conditions around a vehicle on the road at all seasons.



Both models are available in a single or a dual air inlet version.

The Kimax 1 has a keypad with a total of four keys and a display with three LED digits, which is easy to read even in a dark cabin or outside in sunshine.



In daily use you get a read out of the actual load on your axle or axle group.

The display can be set to read out values as xxx tonne/kg - xx,x tonne/kg - x,xx tonne/kg.

6 mm PU hose for air inlets.

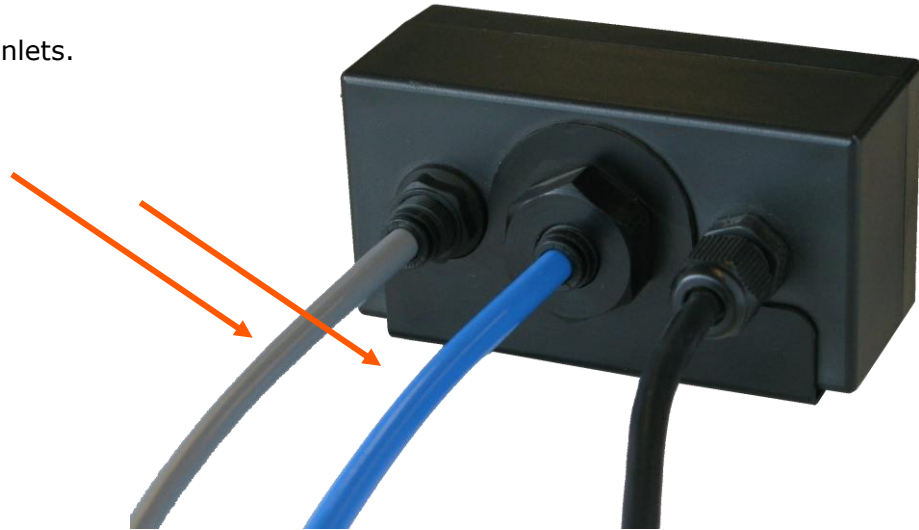

Air inlet 1 for 6 mm hose.

Gore-Tex membrane for venting the Kimax 1 housing, this means you do not get vacuum in the housing under shifting ambient temperatures.

Gore-Tex membrane is only present on the trailer versions of the Kimax 1 instruments.

If you paint the instrument in your own colours, make sure the venting opening in the Gore-Tex membrane is not covered by paint, - put on some tape or a protecting cap before painting.

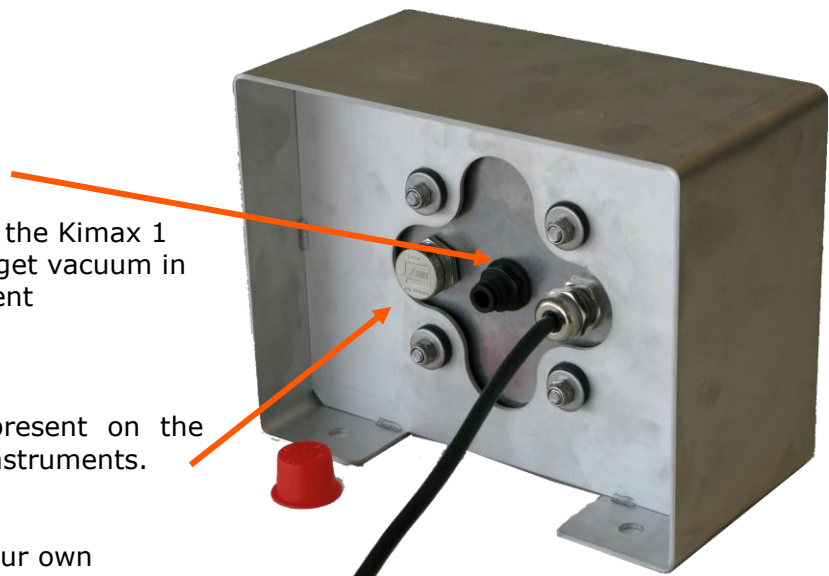

## Serial output

### OBC

Some of the Kimax 1 instruments offer you a RS-232 serial output, displaying the measured values, which you can read on the display.

The string of data is broadcasted every 10<sup>th</sup> seconds and can be transmitted by a GPRS unit e.g. a FM 300 unit to a fleet management system.

As a test, you can set up a "HyperTerminal" on your laptop with the parameters below,

```
Bit pr sec   9.600
Data bit     8
Parity       N
Stopbit      1
Flowcontrol  N
```

and you can read the broadcasted values as numeric characters.

You need to set up your GPRS or FM300 for receiving on the above parameters too.

Due to retransmit the Kimax values through your GPRS unit, or receive the data in a FM300, you can set up a mask: "**AXX.XS**".

#### Protocol:

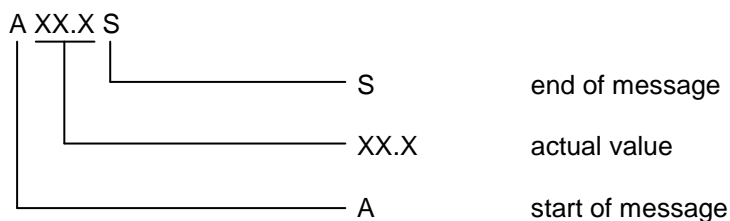

### Printer

Some of the Kimax 1 instruments offer you a RS-232 serial output, for printers.

The string of data is broadcasted every time you access the printer function on the instrument, by pressing  for 3 seconds.

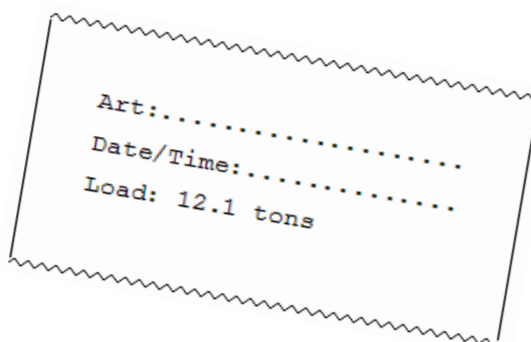

As a test, you can set up a "HyperTerminal" on your laptop with the parameters below, and you can read the broadcasted data.

```
Bit pr sec   4.800
Data bit     8
Parity       N
Stopbit      1
Flowcontrol  N
```



You need to set up your printer for receiving on the above parameters too. Most common printers with serial input can be used with Kimax 1.

## Troubleshooting

Problem	Possible solution
Display is flashing..	Check the A1 setting (see page 11) When the value on the display exceeds the value for A1 the display starts to flash.
Display is blank	Check VS setting (see page 13) 000 = Display blanks after approx. 2 minutes 111 = Display never blanks.  Check wiring (see page 9 and 10)
The value shown oscillates..	Check the air hose for leakage.  Make sure the 0,4 mm hole in the throttle is not blocked.  Recalibrate the instrument.
The value shown is fixed	Check the air hose for leakage.  Make sure the 0,4 mm hole in the throttle is not blocked.  Recalibrate the instrument.
LO value cannot be set higher than HI value setting	If you need to calibrate LO value higher than HI value, change your HI setting to a higher value than your desired LO value.
HI value cannot be set lower than LO value setting	If you need to calibrate HI value lower than LO value, change your LO setting to a lower value than your desired HI value.
Calibration is not possible, the display shows ---, when  or  is pressed..	The unit is locked/protected from changes made in the memory. Check page 16 for unlocking the unit.

If you do not succeed in finding a solution to your issue feel free to contact us.

## Dimensions and technical specifications

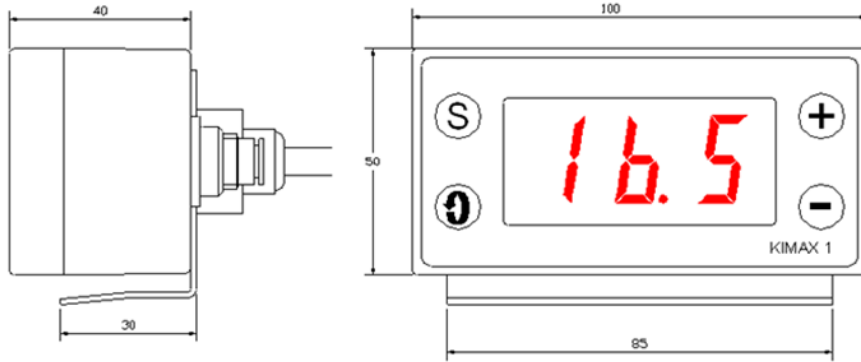

Supply cable

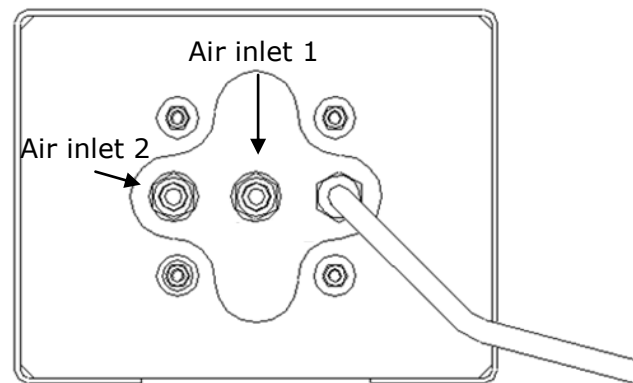
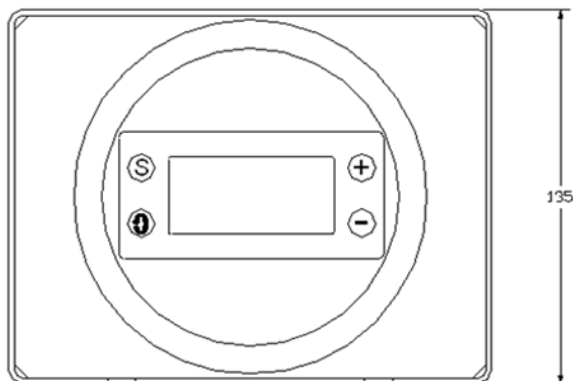
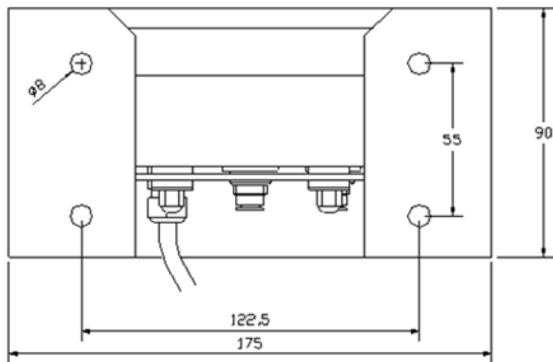
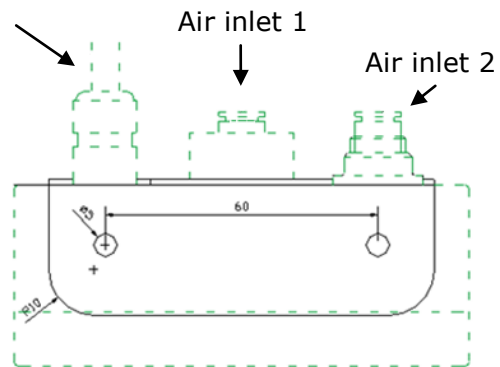

View from rear side

All dimensions are in mm.

## Technical specification Kimax 1 cabin

Supply voltage	10 ... 30 Volt direct current
Current consumption	max. 90 mA
Alarm 1	Flashing display
Alarm 2	NO relay contact max. 0.5 A/30 VDC
Display	Three-digits 7-segment LED, character height 20.3 mm
Decimal position	000 / 00.0 / 0.00
Measuring accuracy	±2 % of maximum load at 0 °C - +50 °C
Air connection	Quick release connection, 6 mm hose
Maximum pressure	15.5 bar (225 psi)
Operating pressure	Range 0 to 10.5 bar (0 to 150 psi)
Operating temperature	-25 °C...+70 °C
Storage temperature	-40 °C...+70 °C
Dimensions	100 x 50 x 40 mm
Cable length	1,5 m - 4 x 0,75 mm <sup>2</sup>
Weight	approx. 240 g
Imperviousness	IP 64
Approval	CE and e1

### Set includes:

#### Kimax 1 cabin 2 sensors

Part number 10001  
 1 x display unit, cabin  
 1 x mounting bracket  
 2 x angle fittings  
 2 x air pressure throttle dia. 6mm  
 2 x T-fitting dia. Ø 8mm / 6mm / 8mm

#### Kimax 1 cabin 1 sensors

Part number 10003  
 1 x display unit, cabin  
 1 x mounting bracket  
 1 x angle fittings  
 1 x air pressure throttle dia. 6mm  
 1 x T-fitting dia. Ø 8mm / 6mm / 8mm

## Technical specification Kimax 1 trailer

Supply voltage	10 ... 30 Volt direct current
Current consumption	max. 90 mA
Alarm 1	Flashing display
Alarm 2	NO relay contact max. 0.5 A/30 VDC
Display	Three-digits 7-segment LED, character height 20.3 mm
Decimal position	000 / 00.0 / 0.00
Measuring accuracy	±2 % of maximum load at 0 °C - +50 °C
Air connection	Quick release connection, 6 mm hose
Maximum pressure	15.5 bar (225 psi)
Operating pressure	Range 0 to 10.5 bar (0 to 150 psi)
Operating temperature	-25 °C...+70 °C
Storage temperature	-40 °C...+70 °C
Dimensions	175 x 135 x 90 mm
Cable length	1,5 m - 4 x 0,75 mm <sup>2</sup>
Weight	approx. 1650 g
Imperviousness	IP 67
Approval	CE and e1

### Set includes:

#### Kimax 1 trailer 2 sensors

Part number 10002  
 1 x display unit, trailer  
 1 x 2 mm sturdy stainless steel frame  
 2 x angle fittings  
 2 x air pressure throttle dia. 6mm  
 2 x T-fitting dia. Ø 8mm / 6mm / 8mm

#### Kimax 1 trailer 1 sensors

Part number 10004  
 1 x display unit, trailer  
 1 x 2 mm sturdy stainless steel frame  
 1 x angle fittings  
 1 x air pressure throttle dia. 6mm  
 1 x T-fitting dia. Ø 8mm / 6mm / 8mm

## Technical specification Kimax 1 cabin - hydraulic

Supply voltage	10 ... 30 Volt direct current	Set includes: <b>Kimax 1 hydraulic</b> Part number 10105 1 x display unit, cabin 1 x mounting bracket 1 x 0–250 bar Hydraulic transmitter ½" inlet 1 x ½" to 3/8" adapter
Current consumption	max. 90 mA	
Alarm 1	Flashing display	
Alarm 2	NO relay contact max. 0.5 A/30 VDC	
Display	Three-digits 7-segment LED, character height 20.3 mm	
Decimal position	000 / 00.0 / 0.00	
Measuring accuracy	±2 % of maximum load at 0 °C - +50 °C	
Maximum pressure	250 bar	
Operating pressure	range 0 to 250 bar	
Operating temperature	-25 °C...+70 °C	
Storage temperature	-40 °C...+70 °C	
Dimensions	100 x 50 x 40 mm	
Cable length	1,5 m - 4 x 0,75 mm <sup>2</sup>	
Weight	approx. 240 g + 250 g sensor	
Imperviousness	IP 64	
Approval	CE and e1	

The policy of Sense-Tech Weighing Systems ApS is to continually improve our products. This means that product specifications may change without prior notice.



**Sense-Tech Weighing Systems ApS** • Bygade 43 A • DK 7173 Vonge • Tel +45 7670 3001 • Fax +45 7670 3002  
mail@sense-tech.com • www.sense-tech.com

MANU\_90001\_002